



**POLARIS®**

# **SPORTSMAN®**



## **2019 OWNER'S MANUAL**

**SPORTSMAN® 570 / SPORTSMAN® 570 EPS / SPORTSMAN® 570 SP  
SPORTSMAN® 570 HD / SPORTSMAN® 570 Utility Edition  
SPORTSMAN® 570 SP Hunter Edition / SPORTSMAN® 450 HD  
SPORTSMAN® 450 HD EPS / SPORTSMAN® 450 HD  
SPORTSMAN® 450 Utility Edition / SPORTSMAN® TOURING 570  
SPORTSMAN® TOURING 570 EPS / SPORTSMAN® TOURING 570 SP  
SPORTSMAN® TOURING 570 EPS / SPORTSMAN® X2 570 EPS  
UTE® 570 HD / SPORTSMAN® 6x6 570**

***Read this manual carefully. It contains important safety information.***

***This is an adult vehicle only.***

***Operation is prohibited for those under 16 years of age.***



## WARNING

Read, understand, and follow all of the instructions and safety precautions in this manual and on all product labels.

Failure to follow the safety precautions could result in serious injury or death.



## WARNING

Operating, servicing, and maintaining a passenger vehicle or off-road vehicle can expose you to chemicals including engine exhaust, carbon monoxide, phthalates, and lead, which are known to the State of California to cause cancer and birth defects or other reproductive harm. To minimize exposure, avoid breathing exhaust, do not idle the engine except as necessary, service your vehicle in a well-ventilated area and wear gloves or wash your hands frequently when servicing your vehicle.

For more information go to [www.P65Warnings.ca.gov/passenger-vehicle](http://www.P65Warnings.ca.gov/passenger-vehicle).



*For videos and more information about a safe riding experience with your Polaris vehicle, scan this QR code with your smartphone.*



## ***2019 Owner's Manual***

**Sportsman® 570**  
**Sportsman® 570 EPS**  
**Sportsman® 570 SP**  
**Sportsman® 570 HD**  
**Sportsman® 570 Utility Edition**  
**Sportsman® 570 Hunter Edition**  
**Sportsman® 6x6 570**  
**Sportsman® 450 HO**  
**Sportsman® 450 HO EPS**  
**Sportsman® 450 HD 2x4**  
**Sportsman® 450 Utility Edition**  
**Sportsman® Touring 570**  
**Sportsman® Touring 570 EPS**  
**Sportsman® Touring 570 SP**  
**Sportsman® X2 570 EPS**  
**UTE® 570 HD**

POLARIS®, ACE™, OUTLAW®, and SPORTSMAN® are trademarks of POLARIS Industries Inc.

Copyright 2018 Polaris Industries Inc. All information contained within this publication is based on the latest product information at the time of publication. Due to constant improvements in the design and quality of production components, some minor discrepancies may result between the actual vehicle and the information presented in this publication. Depictions and/or procedures in this publication are intended for reference use only. No liability can be accepted for omissions or inaccuracies. Any reprinting or reuse of the depictions and/or procedures contained within, whether whole or in part, is expressly prohibited.

The original instructions for this vehicle are in English. Other languages are provided as translations of the original instructions.

Printed in U.S.A.

9929536



Thank you for purchasing a POLARIS vehicle, and welcome to our world-wide family of POLARIS enthusiasts. Be sure to visit us online at [www.polaris.com](http://www.polaris.com) for the latest news, new product introductions, upcoming events, career opportunities and more.

Here at POLARIS we proudly produce an exciting line of utility and recreational products. We believe POLARIS sets a standard of excellence for all utility and recreational vehicles manufactured in the world today. Many years of experience have gone into the engineering, design, and development of your POLARIS vehicle, making it the finest machine we've ever produced.

- Snowmobiles
- SPORTSMAN® All-terrain vehicles
- Low emission vehicles (LEVs)
- *RANGER*® utility vehicles
- BRUTUS® work vehicles
- SLINGSHOT® three wheel motorcycles
- RZR® sport vehicles
- GEM® vehicles
- INDIAN® motorcycles
- POLARIS POWER® generators
- POLARIS DEFENSE® combat vehicles
- Timbersled® Snow Bikes

For safe and enjoyable operation of your vehicle, be sure to follow the instructions and recommendations in this owner's manual. Your manual contains instructions for minor maintenance, but information about major repairs is outlined in the POLARIS Service Manual and can be performed by a factory certified Master Service Dealer® (MSD) technician.

Your POLARIS dealer knows your vehicle best and is interested in your total satisfaction. Your POLARIS dealership can perform all of your service needs during, and after, the warranty period.

WELCOME

---

---

<b>Introduction</b>	<b>7</b>
<b>Safety</b>	<b>11</b>
<b>Features and Controls</b>	<b>37</b>
<b>Operation</b>	<b>69</b>
<b>Winch Guide</b>	<b>91</b>
<b>Emission Control Systems</b>	<b>101</b>
<b>Maintenance</b>	<b>103</b>
<b>Specifications</b>	<b>141</b>
<b>POLARIS Products</b>	<b>165</b>
<b>Troubleshooting</b>	<b>167</b>
<b>Warranty</b>	<b>171</b>
<b>Maintenance Log</b>	<b>179</b>





---

## INTRODUCTION

This POLARIS vehicle is an off-road vehicle. Familiarize yourself with all laws and regulations concerning the operation of this vehicle in your area.

### **WARNING**

Failure to heed the warnings and safety precautions contained in this manual can result in severe injury or death. Your POLARIS vehicle is not a toy and can be hazardous to operate. This vehicle handles differently than cars, trucks or other off-road vehicles. A collision or rollover can occur quickly, even during routine maneuvers like turning, or driving on hills or over obstacles, if you fail to take proper precautions.

- Read this owner's manual and review the safety DVD that came with your vehicle. A free extra copy of the DVD can be obtained by contacting your local POLARIS dealer. Understand all safety warnings, precautions and operating procedures before operating the vehicle. Keep this manual with the vehicle.
- Never operate this vehicle without proper instruction. Take an authorized training course. Visit [www.rohva.org](http://www.rohva.org) or call 866-267-2751.
- This vehicle is an **ADULT VEHICLE ONLY**. You **MUST** be at least age 16 and have a valid driver's license to operate this vehicle.
- Always wear a helmet, eye protection, gloves, long-sleeve shirt, long pants and over-the-ankle boots.
- Never use this vehicle with drugs or alcohol, as these conditions impair judgment and reduce operator reaction time.
- Complete the New Operator Driving Procedures outlined in this manual. Never allow a guest to operate this vehicle until the guest has completed the New Operator Driving Procedures.
- Never permit a guest to operate this vehicle unless the guest has reviewed the owner's manual and all safety labels and has completed a safety training

## INTRODUCTION

---

### **SAFETY SYMBOLS AND SIGNAL WORDS**

The following signal words and symbols appear throughout this manual and on your vehicle. Your safety is involved when these words and symbols are used. Become familiar with their meanings before reading the manual.

#### **DANGER**

DANGER indicates a hazardous situation which, if not avoided, WILL result in death or serious injury.

#### **WARNING**

SAFETY ALERT WARNING indicates a hazardous situation which, if not avoided, COULD result in serious injury.

#### **CAUTION**

SAFETY ALERT CAUTION indicates a hazardous situation which, if not avoided, COULD result in minor to moderate injury.

#### **CAUTION**

CAUTION indicates special precautions that must be taken to avoid vehicle damage or property damage.

#### **IMPORTANT**

IMPORTANT provides key reminders during disassembly, assembly, and inspection of components.

#### **NOTICE**

NOTICE provides key information by clarifying instructions.



The Prohibition Safety Sign indicates an action NOT to take in order to avoid a hazard.



The Mandatory Action Sign indicates an action that NEEDS to be taken to avoid a hazard.

### **EUROPEAN VIBRATION AND NOISE**

The driver-perceived noise and hand/arm and whole body vibration levels of this machinery is measured per EN 15997.

The operating conditions of the machinery during testing:

The vehicles were in like-new condition. The environment was controlled as indicated by the test procedure(s).

The uncertainty of vibration exposure measurement is dependent on many factors, including:

- Instrument and calibration uncertainty
- Variations in the machine such as wear of components
- Variation of machine operators such as experience or physique
- Ability of the worker to reproduce typical work during measurements
- Environmental factors such as ambient noise or temperature

## INTRODUCTION

### VEHICLE IDENTIFICATION NUMBERS

Record your vehicle's identification numbers and key number in the spaces provided. Remove the spare key and store it in a safe place. An ignition key can be duplicated only by ordering a POLARIS key blank (using your key number) and mating it with one of your existing keys. The ignition switch must be replaced if all keys are lost.

The vehicle serial number ① can be found stamped on lower frame rail on the rear left-hand side of the vehicle on all models.

#### NOTE

The figures below are for reference only. Your model may differ slightly.

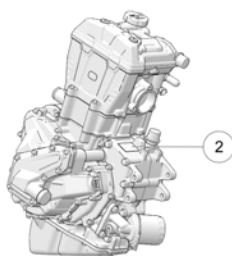
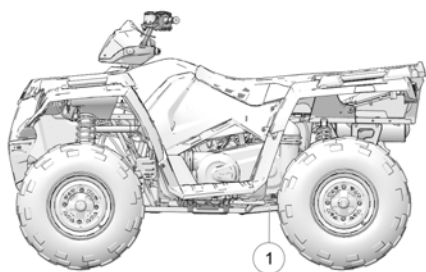

Vehicle Model Number (VIN) ①	
Frame VIN	
Engine Serial Number ②	
Key Number	

## SAFETY

### SAFETY TRAINING

ATV safety training is a top priority for POLARIS. POLARIS strongly encourages you and any family members who will be riding the ATV to take a training course.

If you purchased a new POLARIS ATV in the United States, your dealer provided information about the authorized ATV *RiderCourse*<sup>sm</sup> that is available to you and your eligible family members. This training is included in the purchase price of your ATV. You were also provided with printed materials that explain safe operating procedures. You should review this information on a regular basis.

If you purchased a used POLARIS ATV in the United States, you can enroll in the ATV *RiderCourse*<sup>sm</sup> for a fee. Call ATV Enrollment Express at (800) 887-2887 or visit [www.atvsafety.org](http://www.atvsafety.org). If you purchased a POLARIS ATV outside the United States, please contact your dealer or local law enforcement agencies for information about safety training.

A POLARIS ATV is an off-road vehicle. Familiarize yourself with all laws and regulations concerning the operation of this vehicle in your area. We strongly advise you to strictly follow the recommended maintenance program outlined in your vehicle manual. This preventive maintenance program is designed to ensure that all critical components on your vehicle are thoroughly inspected at specific intervals.

**FOR MORE INFORMATION ABOUT ATV SAFETY in the United States, call the Consumer Product Safety Commission at 1-800-638-2772, or visit [www.cpsc.gov](http://www.cpsc.gov), visit [www.atvsafety.org](http://www.atvsafety.org), or call POLARIS at 1-800-342-3764.**

### SAFE RIDING GEAR

Always wear helmet, eye protection, gloves, long-sleeve shirt, long pants, over-the-ankle boots and seat belt (if equipped) at all times. Protective gear reduces the chance of injury.

- ① Helmet
- ② Eye Protection
- ③ Long Sleeves
- ④ Gloves
- ⑤ Long Pants
- ⑥ Over-the-Ankle Boots



## SAFETY

---

### HELMET

Wearing a helmet can prevent a severe head injury. Whenever riding this POLARIS vehicle, always wear a helmet that meets or exceeds established safety standards.

Approved helmets in the USA and Canada bear a U.S. Department of Transportation (DOT) label.



Approved helmets in Europe, Asia and Oceania bear the ECE 22.05 label. The ECE mark consists of a circle surrounding the letter E, followed by the distinguishing number of the country which has granted approval. The approval number and serial number will also be displayed on the label.

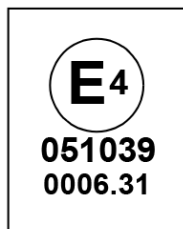

### EYE PROTECTION

Do not depend on eyeglasses or sunglasses for eye protection. Whenever riding this POLARIS vehicle, always wear shatterproof goggles or use a shatterproof helmet face shield. POLARIS recommends wearing approved Personal Protective Equipment (PPE) bearing markings such as VESC 8, V-8, Z87.1, or CE. Make sure protective eye wear is kept clean.

### GLOVES

Wear gloves for comfort and for protection from sun, cold weather and other elements.

### BOOTS

Wear sturdy over-the-ankle boots for support and protection. Never ride a POLARIS vehicle with bare feet or sandals.

### CLOTHING

Wear long sleeves and long pants to protect arms and legs.

## SAFETY WARNINGS

### WARNING

Failure to operate this vehicle properly can result in a collision, loss of control, accident or rollover, which may result in serious injury or death. Heed all safety warnings outlined in this section of the owner's manual and in the safety DVD provided with your vehicle. See the OPERATION section of the owner's manual for proper operating procedures.

## OPERATING WITHOUT INSTRUCTION

Operating this vehicle without proper instruction increases the risk of an accident. The operator must understand how to operate the vehicle properly in different situations and on different types of terrain.

All operators must read and understand the owner's manual and all warning and instruction labels before operating the vehicle.

All operators should review the safety DVD provided with this vehicle and take a ROHVA training course ([www.rohva.org](http://www.rohva.org)).



## AGE RESTRICTIONS

This vehicle is an ADULT VEHICLE ONLY. Operation is prohibited for anyone under 16 years of age or anyone without a valid driver's license.

The operator must be tall enough to sit with back against the seat, both feet flat on the floor and both hands on the steering wheel (if equipped) or handlebars.



## USING ALCOHOL OR DRUGS

Operating this vehicle after consuming alcohol or drugs could adversely affect operator judgment, reaction time, balance and perception.

Never consume alcohol or drugs before or while operating this vehicle.



### FAILURE TO INSPECT BEFORE OPERATING

#### WARNING

Failure to inspect and verify that the vehicle is in safe operating condition before operating increases the risk of an accident.

Always perform the pre-ride inspection before each use of your vehicle to make sure it's in safe operating condition.

Always follow the inspection and maintenance procedures and schedules described in this owner's manual.

### HANDLING GASOLINE

Gasoline is highly flammable and explosive under certain conditions.

- Always exercise extreme caution whenever handling gasoline.
- Always refuel with the engine stopped, and outdoors or in a well ventilated area.
- Do not smoke or allow open flames or sparks in or near the area where refueling is performed or where gasoline is stored.
- Do not overfill the tank. Do not fill the tank neck.
- If gasoline spills on your skin or clothing, immediately wash it off with soap and water and change clothing.

### EXPOSURE TO EXHAUST

Engine exhaust fumes are poisonous and can cause loss of consciousness or death in a short time. Never start the engine or let it run in an enclosed area.

Operate this vehicle only outdoors or in well-ventilated areas.

### PROTECTIVE APPAREL

Riding in this vehicle without wearing an approved helmet and protective eye wear increases the risk of a serious injuries in the event of an accident.

Always wear a helmet, eye protection, gloves, long-sleeve shirt, long pants and over-the-ankle boots.

### OPERATING ON PAVEMENT

This vehicle's tires are designed for off-road use only, not for use on pavement. Operating this vehicle on paved surfaces (including sidewalks, paths, parking lots and driveways) may adversely affect the handling of the vehicle and may increase the risk of loss of control and accident or rollover. Avoid operating the vehicle on pavement. If it's unavoidable, travel slowly, travel short distances and avoid sudden turns or stops.



---

## OPERATING ON PUBLIC ROADS

Operating this vehicle on public streets, roads or highways could result in a collision with another vehicle. Never operate this vehicle on any public street, road or highway, including dirt and gravel roads (unless designated for off-highway use).



## OPERATING AT EXCESSIVE SPEEDS

Operating this vehicle at excessive speeds increases the operator's risk of losing control. Always operate at a speed that's appropriate for the terrain, the visibility and operating conditions and your skills and experience.



## PHYSICAL CONTROL OF THE VEHICLE

Removing even one hand or foot can reduce ability to control the vehicle or could cause loss of balance and ejection from the ATV.

If a person's feet are not firmly planted on the footrests, they could come into contact with the wheels or other moving parts and lead to accident or injury.

Always keep both hands on the handlebars and both feet on the footrests of the ATV during operation.

## TURNING IMPROPERLY

Turning improperly could cause loss of traction, loss of control, accident or rollover. Always follow proper procedures for turning as described in this owner's manual.

Avoid sharp turns. Never turn while applying heavy throttle. Never make abrupt steering maneuvers. Practice turning at slow speeds before attempting to turn at faster speeds.

## SAFETY

---

### JUMPS AND STUNTS

Exhibition driving increases the risk of an accident or rollover. **DO NOT** do power slides, “donuts”, jumps or other driving stunts. Avoid exhibition driving.



### IMPROPER HILL CLIMBING

Improper hill climbing could cause loss of control or rollover. Use extreme caution when operating on hills. Always follow proper procedures for hill climbing as described in this owner's manual. See the New Operator Driving Procedures section for details.

### DESCENDING HILLS IMPROPERLY

Improperly descending a hill could cause loss of control or rollover. Always follow proper procedures for traveling down hills as described in this owner's manual. See the New Operator Driving Procedures section for details.

### CROSSING HILLSIDES

Driving on a sidehill is not recommended. Improper procedure could cause loss of control or rollover. Avoid crossing the side of any hill unless absolutely necessary.

If crossing a hillside is unavoidable, always follow proper procedures as described in this owner's manual. See the New Operator Driving Procedures section for details.

---

## STALLING WHILE CLIMBING A HILL

Stalling, rolling backwards or improperly dismounting while climbing a hill could cause a rollover.

- Always maintain a steady speed when climbing a hill.
- Always move the 4X4 switch to 4WDC (if equipped) before ascending or descending a hill.



*If all forward speed is lost:*

- Lean forward to keep body weight uphill. A passenger should also lean uphill.
- Apply the brakes.
- Lock the parking brake when fully stopped.
- Dismount on the uphill side of the vehicle, or on the left if the vehicle is pointing straight uphill. Have a passenger dismount first, then the operator may dismount.
- Turn the ATV around and remount, following the procedure described in the owner's manual.

*If the ATV begins rolling downhill:*

- Keep operator and passenger body weight uphill.
- Never apply engine power.
- Never apply the rear brake while rolling backwards. Apply the single-lever brake gradually.
- When fully stopped, apply the rear brake as well, and then lock the parking brake.
- Dismount on the uphill side of the vehicle, or on the left if the vehicle is pointing straight uphill. Have a passenger dismount first, then the operator may dismount.
- Turn the ATV around and remount, following the procedure described in the owner's manual.

## SAFETY

---

### OPERATING ON STEEP HILLS

Operating on excessively steep hills could cause an overturn.

Never operate on hills too steep for the ATV or for your abilities.

- Never operate a 1-up ATV on hills steeper than 25 degrees.

### OPERATING ON SLIPPERY TERRAIN

Failure to use extra caution when operating on excessively rough, slippery or loose terrain could cause loss of traction, loss of control, accident or overturn.

Do not operate on excessively rough, slippery or loose terrain until you've learned and practiced the skills necessary to control the vehicle on such terrain.

Always use extra caution on rough, slippery or loose terrain.



### OPERATING IN UNFAMILIAR TERRAIN

Failure to use extra caution when operating on unfamiliar terrain could result in an accident or rollover.

Unfamiliar terrain may contain hidden rocks, bumps, or holes that could cause loss of control or rollover.

Travel slowly and use extra caution when operating on unfamiliar terrain. Always be alert to changing terrain conditions.

### IMPROPER TIRE MAINTENANCE

Operating this vehicle with improper tires or with improper or uneven tire pressure could cause loss of control or accident.

Always use the size and type of tires specified for your vehicle.

Always maintain proper tire pressure as described in the owner's manual and on safety labels.



### OPERATING IMPROPERLY IN REVERSE

Improperly operating in reverse could result in a collision with an obstacle or person. Always follow proper operating procedures as outlined in this manual. See the New Operator Driving Procedures section for details.

Before shifting into reverse gear, always check for obstacles or people behind the vehicle. When it's safe to proceed, back slowly.

---

## OPERATING OVER OBSTACLES

Improperly operating over obstacles could cause loss of control or rollover.

Before operating in a new area, check for obstacles. Avoid operating over large obstacles such as large rocks and fallen trees. Always follow the proper procedures outlined in this manual when operating over obstacles. See the New Operator Driving Procedures section for details.

## SKIDDING OR SLIDING

Failure to use extra caution when operating on excessively rough, slippery or loose terrain could cause loss of traction, loss of control, accident or rollover. Do not operate on excessively slippery surfaces. Always slow down and use additional caution when operating on slippery surfaces.



Skidding or sliding due to loss of traction can cause loss of control or rollover (if tires regain traction unexpectedly). Always follow proper procedures for operating on slippery surfaces as described in this owner's manual. See the New Operator Driving Procedures section for details.

## OPERATING A DAMAGED ATV

Operating a damaged ATV can result in an accident. After any overturn or accident, have a qualified service dealer inspect the entire machine for possible damage, including (but not limited to) brakes, throttle and steering systems.

## OPERATING THROUGH WATER

Operating through deep or fast-flowing water can cause loss of traction, loss of control, rollover or accident. Never operate in fast-flowing water or in water that exceeds the floor level of the vehicle.

Always follow proper procedures for operating in water as described in this owner's manual. See page 74.

Wet brakes may have reduced stopping ability. After leaving water, test the brakes. Apply them lightly several times while driving slowly. The friction will help dry out the pads.

## SAFETY

---

### **IMPROPER CARGO LOADING**

Overloading the vehicle or carrying/towing cargo improperly may cause changes in stability and handling, which could cause loss of control or an accident.

- Always follow the instructions in this owner's manual for carrying cargo.
- Never exceed the stated load capacity for this vehicle.
- Cargo should be properly distributed and securely attached.
- Reduce speed when carrying cargo or pulling a trailer. Allow a greater distance for braking.

### **OPERATING ON FROZEN BODIES OF WATER**

Severe injury or death can result if the vehicle and/or the operator fall through the ice. Never operate the vehicle on a frozen body of water unless you have first verified that the ice is sufficiently thick to support the weight and moving force of the vehicle, you and your cargo, together with any other vehicles in your party.

Always check with local authorities and residents to confirm ice conditions and thickness over your entire route. Vehicle operators assume all risk associated with ice conditions on frozen bodies of water.

### **POOR VISIBILITY**

Operating this vehicle in darkness or inclement weather could result in a collision or accident, especially if operating on a road or street. This vehicle is not equipped with highway-approved lights. Operate this vehicle off-road only. Use caution and drive at reduced speeds in conditions of reduced visibility such as fog, rain and darkness. Clean headlights frequently and replace burned out headlamps promptly.

### **PHYSICAL SKILLS**

Safe operation of this rider-active vehicle requires good judgement and physical skills. Persons with cognitive or physical disabilities who operate this vehicle have an increased risk of overturn and loss of control.

---

## HOT EXHAUST SYSTEMS

### WARNING

Exhaust system components are very hot during and after use of the vehicle. Hot components can cause burns and fire. Do not touch hot exhaust system components. Always keep combustible materials away from the exhaust system.

Use caution when traveling through tall grass, especially dry grass. Always inspect the underside of the vehicle and areas near the exhaust system after driving through tall grass, weeds, brush, and other tall ground cover. Promptly remove any grass or debris clinging to the vehicle.

## UNAUTHORIZED USE OF THE VEHICLE

Leaving the keys in the ignition can lead to unauthorized use of the vehicle by someone under the age of 16, without a drivers license, or without proper training. This could result in an accident or rollover. Always remove the ignition key when the vehicle is not in use.

## EQUIPMENT MODIFICATIONS

Your POLARIS vehicle is designed to provide safe operation when used as directed. Modifications to your vehicle may negatively impact vehicle stability. Failure of critical machine components may result from operation with any modifications, especially those that increase speed or power. This vehicle may become less stable at speeds higher than those for which it is designed. Loss of control may occur at higher speeds.

Do not install any non-POLARIS-approved accessory or modify the vehicle for the purpose of increasing speed or power. Any modifications or installation of non-POLARIS-approved accessories could create a substantial safety hazard and increase the risk of bodily injury.

The POLARIS limited warranty on your POLARIS vehicle will be terminated if any non-POLARIS approved equipment and/or modifications have been added to the vehicle that increase speed or power.

The addition of certain accessories, including (but not limited to) mowers, blades, tires, sprayers, or large racks, may change the handling characteristics of the vehicle. Use only POLARIS-approved accessories, and familiarize yourself with their function and effect on the vehicle.

**FOR MORE INFORMATION ABOUT SAFETY  
call POLARIS at 1-800-342-3764.**

## SAFETY

---

### SAFETY LABELS AND LOCATIONS

Warning labels have been placed on the vehicle for your protection. Read and follow the instructions on each label carefully. If any of the labels shown in this manual differ from the labels on your vehicle, always read and follow the instructions of the labels on the vehicle.

If an informational or graphic label becomes illegible or comes off, contact your POLARIS dealer to purchase a replacement. Replacement safety labels are provided by POLARIS at no charge. The part number is printed on the label.

### GENERAL WARNING

The General ① warning is located on the left-hand side of the vehicle.

#### WARNING

Improper use can result in SEVERE INJURY or DEATH

ALWAYS USE AN APPROVED  
HELMET AND PROTECTIVE GEAR  
NEVER USE ON PUBLIC ROADS  
NEVER CARRY PASSENGERS  
NEVER USE WITH DRUGS OR  
ALCOHOL

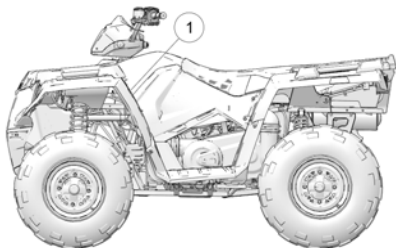

#### **NEVER operate:**

- without proper training or instruction
- at speeds too fast for your skills or the conditions
- on public roads - a collision can occur with another vehicle
- with a passenger - passengers affect balance and steering and increase risk of losing control

#### **ALWAYS:**

- use proper riding techniques to avoid vehicle overturns on hills and rough terrain and in turns
- avoid paved surfaces - pavement may seriously affect handling and control



---

## GENERAL WARNING (2-UP MODELS)



### WARNING

Improper use can result in SEVERE INJURY or DEATH

ALWAYS USE AN APPROVED HELMET AND PROTECTIVE GEAR FOR DRIVER AND PASSENGER

NEVER USE ON PUBLIC ROADS

NEVER CARRY MORE THAN 1 PASSENGERS

NEVER USE WITH DRUGS OR ALCOHOL

### **NEVER operate:**

- without proper training or instruction
- at speeds too fast for your skills or the conditions
- on public roads - a collision can occur with another vehicle
- with a passenger unless passenger seat is securely in place

### **ALWAYS:**

- use proper riding techniques to avoid vehicle overturns on hills and rough terrain and in turns
- avoid paved surfaces - pavement may seriously affect handling and control
- reduce speed and use extra caution at all times when carrying a passenger - dismount passenger when conditions require
- make sure passenger reads and understands this label and passenger safety label

## SAFETY

---

### NO PASSENGER WARNING (1-UP MODELS)

The “No Passenger” warning ② is located on the left-hand side of the vehicle.

#### **WARNING**

NEVER ride as a passenger. Passengers can cause a loss of control, resulting in SEVERE INJURY or DEATH.

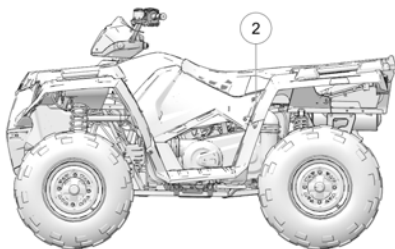

### PASSENGER WARNING (2-UP MODELS)

#### **WARNING**

##### PASSENGER SAFETY

To reduce the risk of SEVERE INJURY or DEATH

NEVER CARRY MORE THAN ONE PASSENGER

NEVER RIDE AFTER USING DRUGS OR ALCOHOL

**NEVER** carry a passenger too small to firmly plant feet on footrests and securely grasp hand holds.

THE PASSENGER MUST **ALWAYS**:

- use an approved helmet and protective gear
- securely grasp hand holds and plant feet firmly on footrests while seated in the passenger seat
- tell operator to slow down or stop if uncomfortable - get off and walk if conditions require

## FUEL TRANSPORT / PASSENGER WARNING (6X6 MODELS)

The Fuel Transport / Passenger warning ③ is located in the cargo box.



### WARNING

Remove flammable material containers from box before filling.

### WARNING

- Passengers can be thrown off. This can cause serious injury or death.
- Never carry passengers.

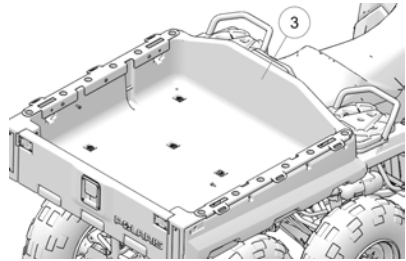

### WARNING

Maximum Box Load 800 lbs.

## AGE 16 WARNING

The Age 16 warning ④ is located on the left-hand wheel well.

### WARNING

Operating this vehicle if you are under the age of 16 increases the chances of severe injury or death to operator.

NEVER operate this vehicle if you are under age 16.

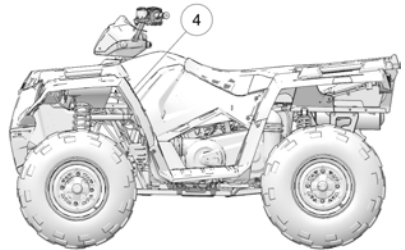

## SAFETY

---

### AGE 16 WARNING (2-UP MODELS)

#### WARNING

Operating this vehicle if you are under the age of 16 increases the chances of severe injury or death to both operator and passenger.

NEVER operate this vehicle if you are under age 16.

### RACK WARNING, FRONT AND REAR

The Rack warning ⑤ can be found on the front and rear racks.

#### WARNING

DO NOT TOW FROM RACK OR BUMPER. Vehicle damage or tipover may result causing severe injury or death. Tow only from tow hooks or hitch. Maximum Rack Loads: Front 90 lbs. (41 kg) Rear 180 lbs. (82 kg)

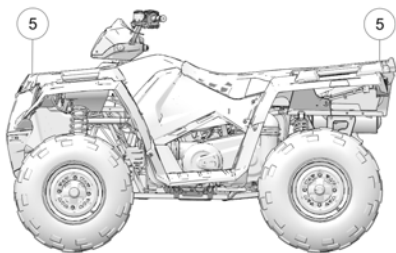

### REVERSE OVERRIDE / AWD WARNING

#### WARNING

Improper use of override button can lead to loss of control resulting in severe injury or death. Do not activate override while throttle is engaged. Always apply throttle gradually, while in reverse.

#### CAUTION

Do not push switch to engage 4X4 (AWD) if the rear wheels are spinning. This may cause severe drive shaft and clutch damage.

### DISCRETIONARY WARNING (1-UP MODELS)

The Discretionary Warning ⑥ is located on the right-hand wheel well.

#### WARNING

- Never operate this ATV on HILLS steeper than 25 degrees. To prevent overturn on hilly terrain, use throttle and brakes gradually, and shift weight uphill.
- REVERSE operation can be dangerous even at low speeds. Steering becomes difficult. To prevent loss of control, avoid sudden braking or sharp turns.

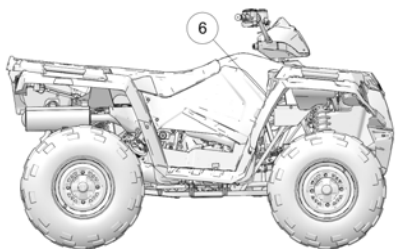

## DISCRETIONARY WARNING (2-UP MODELS)

The Discretionary Warning is located on the right side of the vehicle.

### WARNING

- Never operate this ATV on HILLS steeper than 15 degrees. To prevent overturn on hilly terrain, use throttle and brakes gradually, and shift weight uphill.
- REVERSE operation can be dangerous even at low speeds. Steering becomes difficult. To prevent loss of control, avoid sudden braking or sharp turns.

## CLUTCH COVER WARNING

### WARNING

- Moving parts hazard under belt-clutch guard. To prevent serious injury, do not operate vehicle with guard removed.
- Do not modify engine or clutch. Doing so can cause part failure, possible imbalance, and excessive engine RPM, which can result in serious injury or death.

## TIRE PRESSURE/LOAD WARNING (1-UP MODELS)

The Tire Pressure/Load warning ⑦ is located on the left-hand side of the vehicle.

### WARNING

Improper tire pressure or overloading can cause loss of control. Loss of control can result in severe injury or death.

- Cold tire pressure:
  - Front: 7.0 psi (48.2 kPa)
  - Rear: 7.0 psi (48.2 kPa)
- Maximum weight capacity: 575 lbs. (261 kg)

**NEVER** exceed 50 MPH (80 km/h) when rear cargo loads are above 75 lbs. (34 kg) and/or front cargo loads are above 37 lbs. (17 kg).

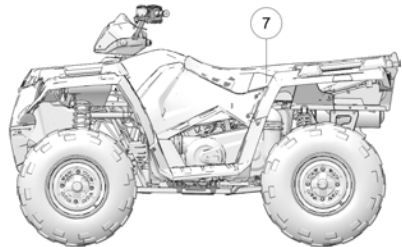

## SAFETY

---

### **TIRE PRESSURE/LOAD WARNING (TOURING MODELS) WARNING**

Improper tire pressure or overloading can cause loss of control. Loss of control can result in severe injury or death.

- Cold tire pressure:
  - Front: 7.0 psi (48.2 kPa)
  - Rear: 7.0 psi (48.2 kPa)
- Maximum weight capacity: 485 lbs. (220 kg)

**NEVER** exceed 50 MPH (80 km/h) when rear cargo loads are above 75 lbs. (34 kg) and/or front cargo loads are above 37 lbs. (17 kg).

**NEVER** exceed 50 MPH (80 km/h) while carrying a passenger.

### **TIRE PRESSURE/LOAD WARNING (6X6 MODELS) WARNING**

Improper tire pressure or overloading can cause loss of control. Loss of control can result in severe injury or death.

- Cold tire pressure:
  - Front: 7.0 psi (48.2 kPa)
  - Center: 10.0 psi (68.9 kPa)
  - Rear: 10.0 psi (68.9 kPa)
- Maximum weight capacity: 1115 lbs. (507 kg)

**NEVER** exceed 50 MPH (80 km/h) when rear cargo loads are above 75 lbs. (34 kg) and/or front cargo loads are above 37 lbs. (17 kg).

**NEVER** exceed 10 MPH (16 km/h) when rear cargo loads are above 200 lbs. (91 kg) and/or front cargo loads are above 100 lbs. (45 kg).

### **4X4 (AWD) WARNING (IF EQUIPPED) WARNING**

Do not push switch to engage 4X4 (AWD) if the rear wheels are spinning. This may cause severe drive shaft and clutch damage.

## INTERNATIONAL SAFETY LABELS

### GENERAL WARNING (1-UP MODELS)



#### **WARNING**

Improper use can result in SEVERE INJURY or DEATH

- READ AND UNDERSTAND YOUR OWNER'S MANUAL
- NEVER OPERATE THIS VEHICLE IF YOU ARE UNDER AGE 16
- ALWAYS USE AN APPROVED HELMET AND PROTECTIVE GEAR
- NEVER USE WITH DRUGS OR ALCOHOL
- NEVER CARRY PASSENGERS
- NEVER USE ON PUBLIC ROADS

# SAFETY

## GENERAL WARNING (2-UP MODELS)



### WARNING

Improper use can result in SEVERE INJURY or DEATH

READ AND UNDERSTAND YOUR OWNER'S MANUAL

NEVER OPERATE THIS VEHICLE IF YOU ARE UNDER AGE 16

ALWAYS USE AN APPROVED HELMET AND PROTECTIVE GEAR

NEVER USE WITH DRUGS OR ALCOHOL

NEVER CARRY MORE THAN ONE PASSENGER

NEVER USE ON PUBLIC ROADS

### FUEL TRANSPORT WARNING

#### WARNING

NEVER carry fuel or other flammable liquids on this vehicle

Failure to follow this instruction could lead to serious burn injuries or death.





**FUEL TRANSPORT / PASSENGER WARNING (6X6 MODELS)****WARNING**

Read and understand your owner's manual

Remove flammable material containers from box before filling.

**WARNING**

- Passengers can be thrown off. This can cause serious injury or death.
- Never carry passengers.

Maximum Box Load 181 kg.

**DISCRETIONARY WARNING (UTE MODELS)****ALERT**

Rear and understand your owner's manual.

Never operate this ATV on HILLS steeper than 25 degrees. To prevent overturn on hilly terrain, use throttle and brakes gradually, and shift weight uphill.

**DISCRETIONARY WARNING (2-UP MODELS)****ALERT**

Rear and understand your owner's manual.

Never operate this ATV on HILLS steeper than 15 degrees. To prevent overturn on hilly terrain, use throttle and brakes gradually, and shift weight uphill.



## SAFETY

---

### TIRE PRESSURE/LOAD WARNING (1-UP MODELS)

#### ALERT

Improper tire pressure or overloading can cause loss of control. Loss of control can result in severe injury or death. Always read and understand your owner's manual.

Cold tire pressure:

Front: 48,3 kPa (7.0 psi)

Rear: 48,3 kPa (7.0 psi)



### TIRE PRESSURE/LOAD WARNING (2-UP MODELS)

#### WARNING

Improper tire pressure or overloading can cause loss of control. Loss of control can result in severe injury or death.

Cold tire pressure:

Front: 7.0 psi (48.3 kPa)

Rear: 7.0 psi (48.3 kPa)

Maximum weight capacity: 705 lbs. (320 kg)

Lug nut torque values:

Steel rims – 27 ft-lbs (37 Nm)

Aluminum rims – 30 ft-lbs (41 Nm) + 1/4 turn

**NEVER** exceed 50 MPH (80 km/h) when rear cargo loads are above 75 lbs. (34 kg) and/or front cargo loads are above 37 lbs. (17 kg).

**NEVER** exceed 50 MPH (80 kph) while carrying a passenger.

**NEVER** exceed 10 MPH (16 kph) when rear cargo loads are above 200 lbs (91 kg) and/or front cargo loads are 90 lbs (41 kg).

## TIRE PRESSURE/LOAD WARNING (X2) WARNING

Improper tire pressure or overloading can cause loss of control. Loss of control can result in severe injury or death.

- Cold tire pressure:
  - Front: 7.0 psi (48.3 kPa)
  - Rear: 7.0 psi (48.3 kPa)
- Maximum weight capacity: 705 lbs. (320 kg)
- NEVER exceed 50 MPH (80 km/h) when rear cargo loads are above 75 lbs. (34 kg) and/or front cargo loads are above 37 lbs. (17 kg).
- NEVER exceed 50 MPH (80 km/h) while carrying a passenger.
- NEVER exceed 10 MPH (16 km/h) when rear cargo loads are above 200 lbs. (91 kg) and/or front cargo loads are above 90 lbs. (41 kg).
- Lug nut torque values:
  - Steel rims 27 ft-lbs. (37 Nm)
  - Aluminum rims 30 ft-lbs. (41 Nm) + 1/4 Turn

## AGE 16 WARNING

### WARNING

Operating this ATV if you are under the age of 16 increases the chances of severe injury or death to both operator and passenger.

**NEVER** operate this vehicle if you are under age 16.



## CLUTCH COVER WARNING

### ALERT

- Moving parts hazard under belt-clutch guard. To prevent serious injury, do not operate vehicle with guard removed.
- Do not modify engine or clutch. Doing so can cause part failure, possible imbalance, and excessive engine RPM, which can result in serious injury or death.



## SAFETY

---

### REVERSE OVERRIDE / AWD WARNING

#### ALERT

Read and understand your owner's manual.

Improper use of override button can lead to loss of control resulting in severe injury or death. Do not activate override while throttle is engaged. Always apply throttle gradually, while in reverse.

Do not push switch to engage 4X4 (AWD) if the rear wheels are spinning. This may cause severe drive shaft and clutch damage.



### REVERSE OVERRIDE WARNING (HD MODELS)

#### ALERT

Read and understand your owner's manual.

Improper use of override button can lead to loss of control resulting in severe injury or death. Do not activate override while throttle is engaged. Always apply throttle gradually, while in reverse.



**AWD WARNING (HD MODELS)****ALERT**

Read and understand your owner's manual.

Do not push switch to engage 4X4 (AWD) if the rear wheels are spinning. This may cause severe drive shaft and clutch damage.

**RACK ALERT****ALERT**

DO NOT TOW FROM RACK OR BUMPER.

Tow only from tow hooks or hitch.

Maximum Rack Loads:

- FRONT – 41 kg
- REAR – 82 kg

**RACK ALERT, FRONT (X2)****ALERT**

DO NOT TOW FROM RACK OR BUMPER. Vehicle damage or tipover may result causing severe injury or death. Tow only from tow hooks or hitch.

Maximum combined Front Rack and Container Load: 90 lbs. (41 kg)

**BOX WARNING (X2)****WARNING**

Remove flammable material containers from box before filling.

**WARNING**

Passengers can be thrown off. This can cause serious injury or death. Never carry passengers in cargo box.

Maximum Box Load - 400 lbs. (181 kg)



# FEATURES AND CONTROLS

## SWITCHES



① Ignition Switch

④ Headlight Switch

② Engine Stop Switch

⑤ 4x4 Switch

③ Mode/Reverse Override Switch

## IGNITION SWITCH/LIGHT SWITCH

Use the ignition switch to start the engine. The key can be removed from the switch when it is in the OFF position.

OFF	Turn the key to the OFF position to stop the engine. Electrical circuits are off.
RUN	Turn the key the RUN position to activate electrical components. Electrical circuits are on. Electrical equipment can be used.
START	Turn the key to the START position to engage the electric starter. See the Starting the Engine section for starting procedures.

## FEATURES AND CONTROLS

### 4X4 SWITCH (IF EQUIPPED)

The drive mode switch ① controls the All Wheel Drive (AWD/4X4) system. Use this switch to engage AWD (4X4) or 2X4. The vehicle automatically engages 4X4 when operating in reverse if the drive mode is set to AWD (4X4).

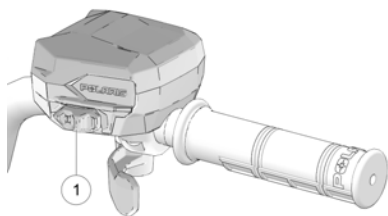

### ENGINE STOP SWITCH

Move the stop switch ② either left or right to the OFF position to stop the engine quickly.

Move the stop switch to the RUN position before attempting to start the engine. The engine will not start or run when the switch is off. Both the main switch and the engine stop switch will shut off all electrical power to the vehicle, including lights.

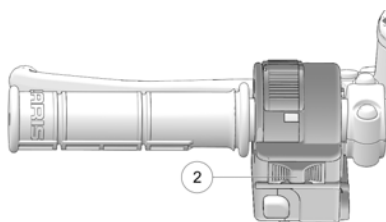

### MODE/REVERSE OVERRIDE SWITCH

#### WARNING

Pressing the override button while the throttle is open can cause loss of control, which may result in serious injury or death. Always release the throttle before pressing the override button.

This vehicle is equipped with a reverse speed limiter system. To gain additional wheel speed while backing, release the throttle and depress the override button ③. The reverse override button also acts as a MODE button when held down for approximately one half second. The override button will not function as a MODE button if the transmission is in reverse.

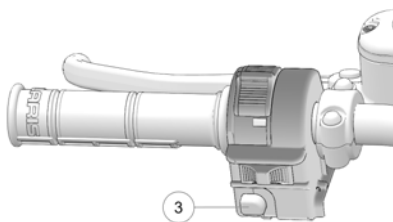



### HEADLIGHT SWITCH

Use the headlight switch to turn the lights on and off and to change the lights from high beam to low beam. The key must be in the ON position and the engine stop switch must be in the RUN position.

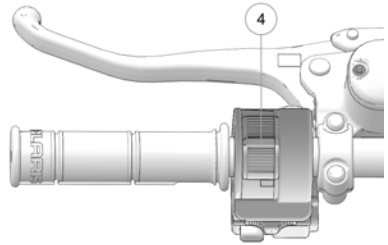

### AUXILIARY OUTLET

The vehicle is equipped with a 12-volt accessory outlet on the dash. Use the outlet to power an auxiliary light or other optional accessories or lights. For service, the dash outlet connection is under the dash.



### THROTTLE LEVER

#### **⚠ WARNING**

Operating an ATV with sticking or improperly operating throttle controls could cause an accident. Never start or operate an ATV that has a sticking or improperly operating throttle. Immediately contact your POLARIS dealer or other qualified person for service if throttle problems arise.

Failure to check or maintain proper operation of the throttle system can result in an accident if the throttle lever sticks during operation. Always check the lever for free movement and return before starting the engine. Also check occasionally during operation.

Modifications to the electronic throttle control could result in failure to perform as designed, which could result in an accident. Do not attempt to modify the throttle control system or replace it with any after market throttle mechanisms.

Engine speed and vehicle movement are controlled by pressing the throttle lever ①. The throttle lever is spring loaded. Engine speed returns to idle when the lever is released. This ATV is equipped with a throttle release switch, which is designed to reduce the risk of a frozen or stuck throttle.

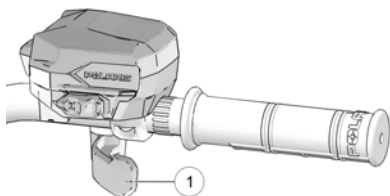

## BRAKE LEVER

### WARNING

Operating the ATV with a spongy brake lever can result in loss of braking, which could cause an accident. Never operate the ATV with a spongy-feeling brake lever. Always contact your dealer for service before operating the vehicle.

Squeeze the brake lever ① toward the handlebar to apply the front and rear brakes. These brakes are hydraulically activated disc type brakes that are activated by only one lever. Always test brake lever travel and master cylinder fluid level before riding. When squeezed, the lever should feel firm. Any sponginess would indicate a possible fluid leak or low master cylinder fluid level, which must be corrected before riding. Contact your POLARIS dealer or other qualified service facility for proper diagnosis and repairs.

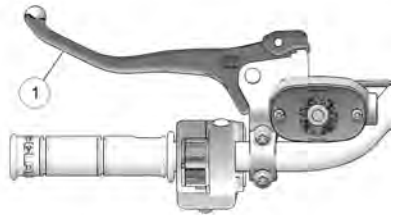

### MASTER CYLINDER/BRAKE FLUID

#### WARNING

An over-full master cylinder may cause brake drag or brake lock-up, which could result in an accident. Maintain brake fluid at the recommended level. Do not overfill.

Never store or use a partial bottle of brake fluid. Brake fluid is hygroscopic, meaning it rapidly absorbs moisture from the air. The moisture causes the boiling temperature of the brake fluid to drop, which can lead to early brake fade and the possibility of brake failure, which could result in an accident. After opening a bottle of brake fluid, always discard any unused portion.

Check the brake fluid in the master cylinder before each ride.

1. Position the ATV on a level surface.
2. Position the handlebars so the master cylinder ① is level.
3. View the brake fluid level through the indicator window ② on the top of the master cylinder. The eye will appear dark when the fluid level is full. When fluid is low, the eye will be clear.
4. If the fluid level is low, remove the cover screws and add fluid to the fill line. *Do not overfill.* Use DOT 4 brake fluid only.
5. Reinstall the cover. Torque screws to 7 in-lbs (.8 Nm).

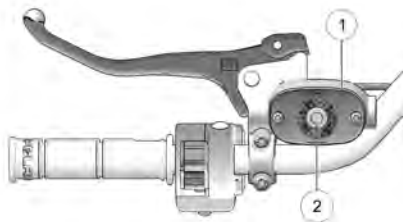

## PARKING BRAKE

### LOCKING THE PARKING BRAKE

#### WARNING

Operating the ATV while the parking brake is engaged could result in an accident or fire. Always check to be sure the parking brake is disengaged before operating.

1. Place the transmission in PARK.
2. Squeeze and release the brake lever ① two or three times, then squeeze and hold.
3. Push the parking brake lock ② forward to engage the lock.
4. Release the brake lever.
5. To release the parking brake lock, squeeze and release the brake lever. It will return to its unlocked position.

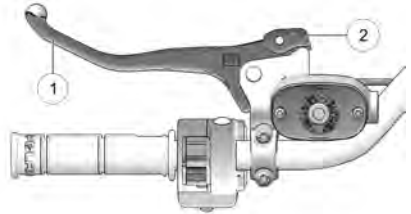

The parking brake may relax if left on for a long period of time. Always block the wheels to prevent rolling. Always block the wheels on the downhill side of the ATV if leaving it parked on a hill. Another option is to park the ATV in a sidehill position. Never depend on the parking brake alone if the ATV is parked on a hill. Always block the wheels to prevent rolling.

### AUXILIARY FOOT BRAKE

#### **⚠ WARNING**

Never back down a hill. Applying the auxiliary brake when backing down a hill may cause rear tipover, which could result in serious injury or death. Use caution when applying the auxiliary brake. Do not aggressively apply the auxiliary brake when going forward. The rear wheels may skid and slide sideways, causing loss of control and serious injury or death.

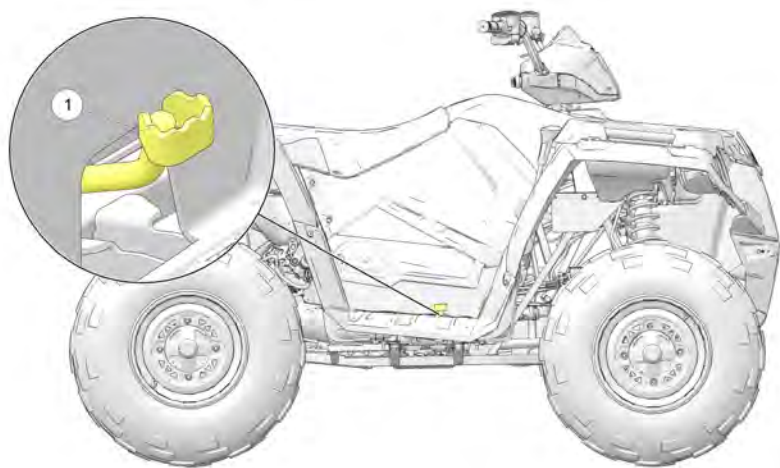

The auxiliary brake system is intended to be used as a backup for the main brake system. Should the main system fail, use the auxiliary foot brake ①. The auxiliary foot brake is located on the inside of the right footrest. Operate this brake with your right foot. If the rear wheels slide while using the auxiliary brake, *reduce* brake pedal pressure to brake the rear wheels without skidding.

### **BRAKE FLUID LEVEL**

Check the brake fluid level frequently for the auxiliary brake system. The reservoir is located under the seat, near the airbox.

Maintain the fluid level between the maximum and minimum marks. Use DOT 4 brake fluid only.



## AUTOMATIC TRANSMISSION GEAR SELECTOR

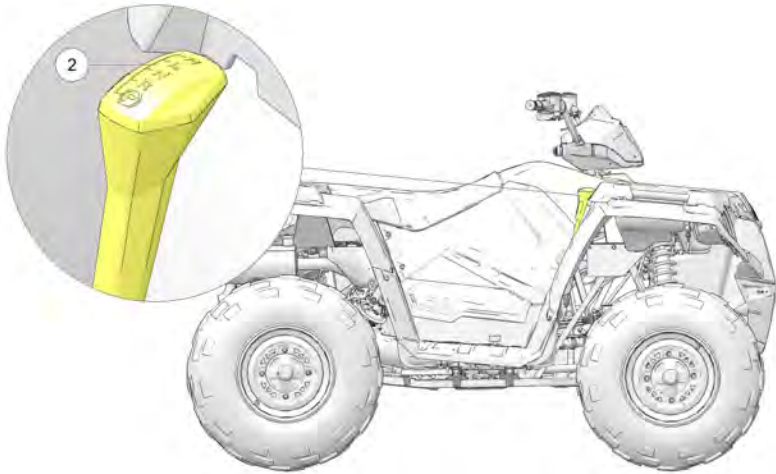

The transmission gear selector ② is located on the right side of the vehicle.

**H:** High Gear  
**L:** Low Gear  
**N:** Neutral  
**R:** Reverse  
**P:** Park



To shift gears, brake to a complete stop.  
 When the engine is idling, move the lever to the desired gear.

### NOTE

Shifting gears with the engine speed above idle or while the vehicle is moving could cause transmission damage.

Whenever the ATV is left unattended, always place the transmission in PARK and lock the parking brake.

### TIP

To extend belt life, use low forward gear when pulling a heavy load at less than seven miles per hour for extended periods and when operating uphill at a slow speed.

## FEATURES AND CONTROLS

---

### FUEL CAP

This vehicle is equipped with a digital fuel gauge that will indicate a low fuel condition. Refuel when the gauge indicates a low fuel condition.

Always refuel with the engine stopped, and outdoors or in a well ventilated area. Refuel on a level surface.

Remove the fuel tank cap to add fuel to the fuel tank. Use either leaded or unleaded gasoline with a minimum pump octane number of 87 = (R + M/2) octane. Do not use fuel with ethanol content greater than 10 percent, such as E-85 fuel.



### PASSENGER SEAT BACKREST (TOURING)

The passenger backrest can be adjusted vertically.

1. Remove the five screws securing the plastic seat cover. Lift the cover upward to remove it from the backrest frame.
2. To adjust the backrest upward or downward, loosen the four vertical adjustment bolts ① on the back of the backrest frame. Slide the backrest upward or downward to the desired position and tighten the adjustment bolts.
3. Reinstall the backrest cover.

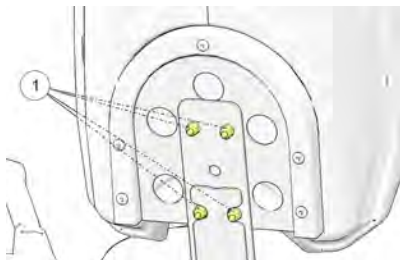



### PASSENGER SEAT (X2)

Always make sure the passenger seat lock-out is functioning properly before operating with a passenger.

Do not operate the vehicle with the seat in the 2-up position when operating without a passenger. Always return the seat to the 1-up position for single-rider operation.

Never carry cargo in the rear box when operating the ATV in the 2-up mode with a passenger.

### SEAT CONVERSION

To convert the back cargo rack to a passenger backrest, do the following:

1. Make sure the cargo box dump latch is securely latched.
2. Slide the seat latch levers inward to release the locks.
3. Tilt the backrest slightly forward.
4. Pull the passenger backrest upward from the bed of the cargo box.
5. Lift the adjustment latch at the top of the passenger backrest. Raise the backrest to the desired position. Release the latch, making sure it locks into one of the three operating positions.

#### TIP

The backrest must be moved out of the lowest position before it can be secured in the upright position. The lowest position is for seat storage only. Do not leave the backrest in the lowest position. Always adjust the backrest to one of the three operating positions.

6. Lower the operator backrest to create the passenger seat. Two retaining pins under the seat should fit into the two grommets on the seat base.
7. Test the passenger seat lockout by attempting to release the cargo box dump latch. If the dump latch releases, the seat is not secure. Repeat the set-up procedure. If the lock-out is not working properly, do not allow a passenger to ride the vehicle. See your POLARIS dealer for service.
8. To return the vehicle to single-rider operation, reverse all steps. Always lower the passenger backrest to the lowest position before folding it down into the cargo box. Slide the seat latch levers outward to secure the locks.

### ELECTRONIC POWER STEERING (EPS)

Electronic power steering (EPS), if equipped, engages when the ignition key is turned to the ON position. EPS remains engaged whether the vehicle is moving or idle. See the Instrument Cluster section for EPS Warning Indicator information.

## FEATURES AND CONTROLS

---

### EXTREME USE BATTERY

An optional extreme use battery may be available for your model. If the performance of the factory-installed battery is inadequate due to operation in extreme cold or due to extended use of multiple electrical accessories, your POLARIS dealer can assist. Your dealer can provide any installation procedures that may differ for an extreme use battery.

### ALL WHEEL DRIVE SYSTEM

The All Wheel Drive system is controlled by the 4X4 switch.

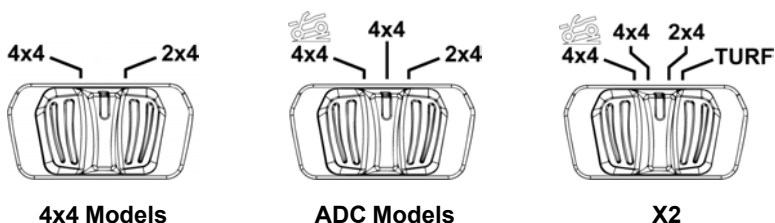

### ADC 4X4 MODE

When the switch is on ADC 4X4, the ADC system allows engine braking to all four wheels when the vehicle descends a hill or incline. Always move the 4X4 switch to ADC 4X4 before ascending or descending a hill.

### 4X4 MODE

When the switch is on 4X4, the ATV is four-wheel drive, and the 4X4 indicator icon in the instrument cluster display will be visible.

When in 4X4, the demand drive unit will automatically engage any time the rear wheels lose traction. When the rear wheels regain traction, the demand drive unit will automatically disengage.

There is no limit to the length of time the vehicle may remain in 4X4. The vehicle automatically engages 4X4 when operating in reverse if the switch is set to either 4X4 position.

### 2X4 MODE

When the switch is on 2X4, the ATV is in two-wheel drive at all times.

### TURF MODE (IF EQUIPPED)

When operating in TURF mode, the inside rear wheel will rotate independently from the outside wheel during turns. Operate in TURF mode only as needed to protect smooth, level surfaces from tire damage. DO NOT operate in TURF mode when climbing or descending hills, when sidehilling, or when operating on uneven, loose, or slippery terrain such as sand, gravel, ice, snow, obstacles, and water crossings. Always operate in ADC 4X4 or 4X4 on these types of terrain.

#### **WARNING**

Operating in TURF mode when on sloped, uneven, or loose terrain could cause loss of control and result in serious injury or death. One rear wheel may slip and lose traction or may lift up and grab when it touches the ground again.

### ENGAGING 4X4

The 4X4 switch may be turned on or off while the vehicle is moving. Initially, the vehicle's electronic system will not enable 4X4 until the engine RPM is below 3000. Once enabled, 4X4 remains enabled until the 4X4 switch is turned off. If the switch is turned off while the demand drive unit is moving, it will not disengage until the rear wheels regain traction.

Engage the 4X4 switch before getting into conditions where front wheel drive may be needed. If the rear wheels are spinning, release the throttle before switching to 4X4.

#### **NOTICE**

Switching to 4X4 or ADC 4X4 while the rear wheels are spinning may cause severe drive shaft and gearcase damage. Always switch to 4X4 or ADC 4X4 while the rear wheels have traction or are at rest.

## FEATURES AND CONTROLS

### ALL WHEEL DRIVE SYSTEM (UTILITY EDITION & UTE MODELS ONLY)

The All Wheel Drive system is controlled by the AWD momentary switch ①.

Engage AWD before getting into conditions where front wheel drive may be needed. If the rear wheels are spinning, release the throttle before switching to AWD.

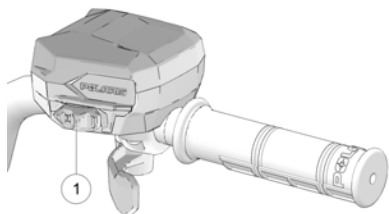

- Move the momentary switch to the right to engage AWD.
- Move the momentary switch to the right, past the AWD setting, to engage ADC AWD (if equipped).
- Move the momentary switch to the far left to operate in two-wheel drive (2X4).

#### NOTICE

Switching to AWD or ADC AWD (if equipped) while the rear wheels are spinning may cause severe drive shaft and gearcase damage. Always switch to AWD or ADC AWD (if equipped) while the rear wheels have traction or are at rest.

#### AWD MODE

Move the momentary switch to the right to engage AWD (4X4). AWD will engage when engine speed slows to below 3100 RPM. The gauge will display "AWD".

There is no limit to the length of time the vehicle may remain in AWD. The vehicle automatically engages AWD when operating in reverse if the switch is set to the AWD position.

Once enabled, AWD remains enabled until the switch is turned off. If the switch is turned off while the demand drive unit is moving, it will not disengage until the rear wheels regain traction.

When in AWD, the demand drive unit will automatically engage any time the rear wheels lose traction. When the rear wheels regain traction, the demand drive unit will automatically disengage.

#### 2X4 MODE

Move the momentary switch to the far left to operate in two-wheel drive (2X4). AWD will disengage when engine speed slows to below 3100 RPM. The gauge will display "2X4."

### ADC AWD MODE (IF EQUIPPED)

Move the momentary switch to the right, past the AWD setting, to engage ADC AWD (if equipped). When the switch is on ADC AWD, the ADC system allows engine braking to all four wheels when the vehicle descends a hill or incline. Always move the AWD switch to ADC AWD before ascending or descending a hill.

### ACTIVE DESCENT CONTROL (ADC) SYSTEM

The ADC system allows engine braking to all four wheels when the vehicle descends a hill or incline. Always move the 4X4 switch to ADC 4X4 before ascending or descending a hill.

### ENGAGING ACTIVE DESCENT CONTROL

The ADC system will automatically engage when *all four* of the following conditions occur:

- The 4X4 switch must be in the ADC 4X4 position
- Vehicle speed must be 15 MPH (25 km/h) or less
- The throttle must be closed (throttle lever released)
- The transmission must be in gear (high, low or reverse)

### DISENGAGING ACTIVE DESCENT CONTROL

The ADC system will automatically disengage if *at least one* of the following conditions occur:

- The 4X4 switch is moved out of the ADC 4X4 position
- Vehicle speed exceeds 15 MPH (25 km/h)
- The throttle is open (throttle is applied)
- The transmission is shifted to neutral or park
- **X2 Model:** The vehicle is on flat ground, or not actively descending a hill

## INSTRUMENT CLUSTER

### OVERVIEW

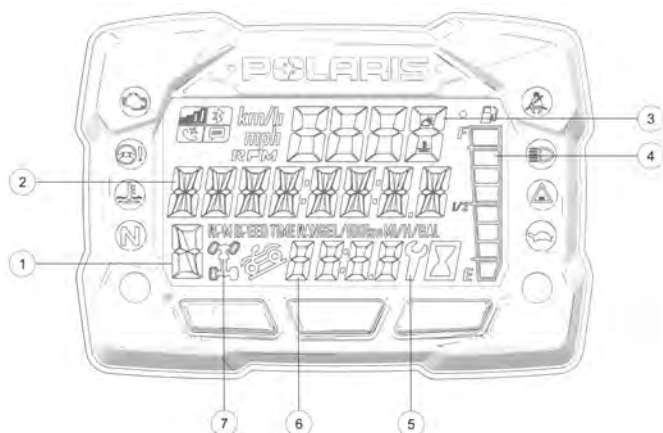









### NOTICE

The use of a high pressure washer may damage the instrument cluster. Wash the vehicle by hand or with a garden hose using mild soap. Do not use alcohol to clean the instrument cluster. Do not allow insect sprays to contact the lens. Immediately clean off any gasoline that splashes on the instrument cluster.

① <b>Gear Indicator</b>	H = High Gear L = Low Gear N = Neutral R = Reverse Gear P = Park -- = Gear Signal Error (or shifter between gears)
② <b>Display Area 2</b>	This area displays odometer, trip meter, trip meter 2, voltage, engine temperature, engine hour meter, programmable service hour interval, ground speed, or engine RPM.
③ <b>Display Area 1</b>	This area displays engine RPM, ground speed, or coolant temperature.
④ <b>Fuel Gauge</b>	The segments of the fuel gauge show the level of fuel in the fuel tank. When the last segment clears, a low fuel warning is activated. All segments including the fuel icon will flash. Refuel immediately.
⑤ <b>Service Indicator</b>	A flashing wrench symbol alerts the operator that the preset service interval has been reached. Your POLARIS dealer can provide scheduled maintenance. See page 62 for more information.
⑥ <b>Clock</b>	The clock displays time in a 12-hour or 24-hour format.
⑦ <b>AWD Indicator</b>	Segments of the indicator illuminate based on drive mode engaged.

## INDICATOR LAMPS



① Check Engine		This indicator appears if an EFI-related fault occurs. Do not operate the vehicle if this warning appears. Serious engine damage could result. Your authorized POLARIS dealer can assist.
② EPS Warning (if equipped)		This indicator illuminates when a fault has occurred in the EPS system. Your authorized POLARIS dealer can assist. EPS operation is possible with key on/engine off for up to 5 minutes.
③ Engine Hot		This lamp illuminates to indicate an overheated engine. If the indicator flashes, a severe overheating condition exists.
④ Neutral		This lamp illuminates when the transmission is in neutral and the ignition key is in the ON position.
⑤ Helmet/Seat Belt		This lamp flashes for several seconds when the key is turned to the ON position. The lamp is a reminder to wear helmet and seat belt (if equipped) before operating.
⑥ High Beam		This lamp illuminates when the headlamp switch is set to high beam.
⑦ Chassis Fault		If applicable.
⑧ Performance Limited		On models equipped with a low speed limiter, indicator light will remain on when low speed limiter is active.

## FEATURES AND CONTROLS

### DISPLAY AREA 1



Pressing the MODE button will change the information displayed in Area 1 ①.

Speed



Engine Temperature



RPM



Ambient Temperature (Optional)





DISPLAY AREA 2



Toggle the Up/Down buttons to change the information displayed in Area 2 ②.

Odometer		Engine Temperature	
Trip 1		Ambient Temperature (Optional)	
Trip 2		RPM	
Voltage		Speed	
Engine Hours		Service Hours	

## FEATURES AND CONTROLS

### OPTIONS MENU



Press and hold the MODE button to enter the Options Menu.

OPTIONS MENU	NOTES
Diagnostic Codes	Only displays if fault codes are present or stored
Units - Distance	Select MPH or KPH
Units - Temp	Select between °F and °C
Clock	Select between 12H or 24H, and set time
Backlight Color	Select between Blue or Red
Backlight Level	Set backlight brightness level
Service Hours	View/Set Service hours
Exit Menu	Exit

**UNIT SELECTION DISTANCE**

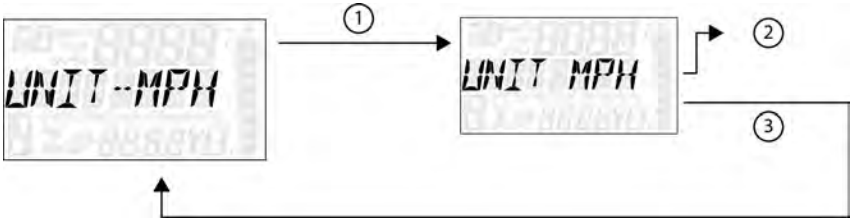

1. Press and hold the MODE button to enter the Options Menu.

**NOTICE**

“OPTIONS” will display on the screen for 3 seconds before showing first menu item.

2. Select “Units-Distance” from the Options Menu by pressing the MODE button.

Reference the image shown above:

- ① Press the MODE button.
- ② Toggle the Up/Down Buttons to change the units (MPH or KPH)
- ③ With the correct unit displayed, Press the mode button which will set the unit and return to the Options Menu.

3. To exit the Options Menu the user can select Exit Menu function from Options Menu, can hold Mode Button and exit out of Options Menu, or not press any button for 10 seconds, which will exit out of the Options Menu.

## FEATURES AND CONTROLS

---

### UNIT SELECTION TEMPERATURE

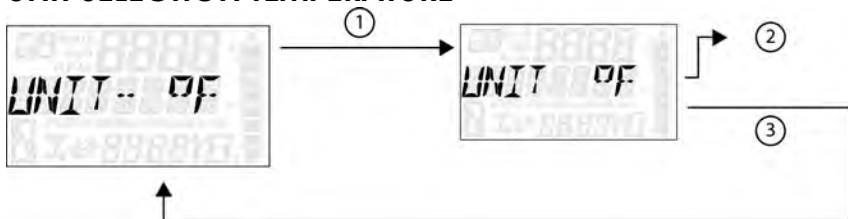

1. Press and hold the MODE button to enter the Options Menu.

#### **NOTICE**

"OPTIONS" will display on the screen for 3 seconds before showing first menu item.

2. Select "Units - Temp" from the Options Menu by pressing the MODE button.

Reference the image shown above:

- ① Press the MODE button.
  - ② Toggle the Up/Down Buttons to change the units (°F or °C)
  - ③ With the correct unit displayed, Press the mode button which will set the unit and return to the Options Menu.
3. To exit the Options Menu the user can select Exit Menu function from Options Menu, can hold Mode Button and exit out of Options Menu, or not press any button for 10 seconds, which will exit out of the Options Menu.

**CLOCK**

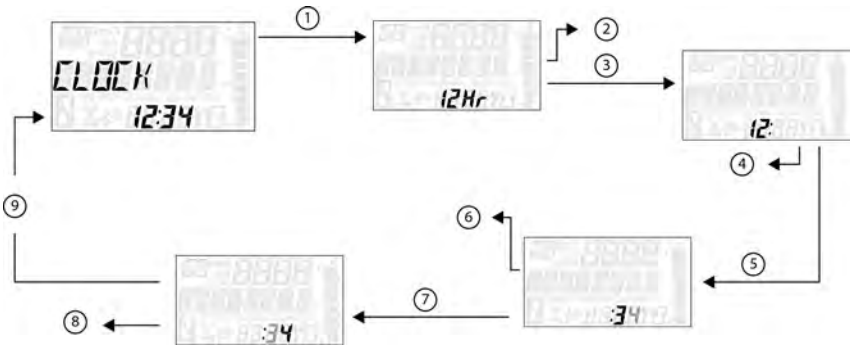

1. Press and hold the MODE button to enter the Options Menu.

**NOTICE**

“OPTIONS” will display on the screen for 3 seconds before showing first menu item.

2. Select “Clock” from the Options Menu by pressing the MODE button.

Reference the image shown above:

- ① Press the MODE button.
- ② Toggle the Up/Down Buttons to change the units (12H or 24H)
- ③ With the correct unit displayed, Press the mode button which will set the unit.
- ④ Toggle the Up/Down Buttons to change the units (Cycles Hours)
- ⑤ With the correct unit displayed, Press the mode button which will set the unit.
- ⑥ Toggle the Up/Down Buttons to change the units (Cycles 10s of Minutes)
- ⑦ With the correct unit displayed, Press the mode button which will set the unit.
- ⑧ Toggle the Up/Down Buttons to change the units (Cycles 1s of Minutes)
- ⑨ With the correct unit displayed, Press the mode button which will set the unit and return to the Options Menu.

## FEATURES AND CONTROLS

---

3. To exit the Options Menu the user can select Exit Menu function from Options Menu, can hold Mode Button and exit out of Options Menu, or not press any button for 10 seconds, which will exit out of the Options Menu.

### BACK LIGHT COLOR

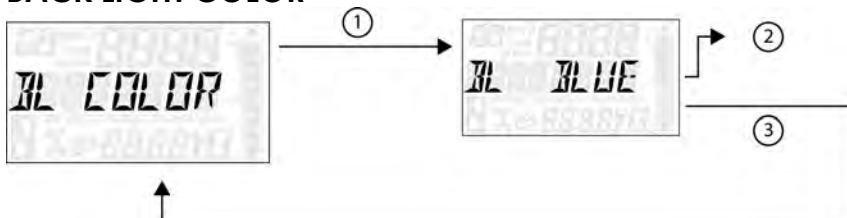

1. Press and hold the MODE button to enter the Options Menu.

#### **NOTICE**

“OPTIONS” will display on the screen for 3 seconds before showing first menu item.

2. Select “Backlight Color” from the Options Menu by pressing the MODE button.

Reference the image shown above:

- ① Press the MODE button.
  - ② Toggle the Up/Down Buttons to change the units (Blue or Red)
  - ③ With the correct unit displayed, Press the mode button which will set the unit and return to the Options Menu.
3. To exit the Options Menu the user can select Exit Menu function from Options Menu, can hold Mode Button and exit out of Options Menu, or not press any button for 10 seconds, which will exit out of the Options Menu.

## BACK LIGHT LEVEL

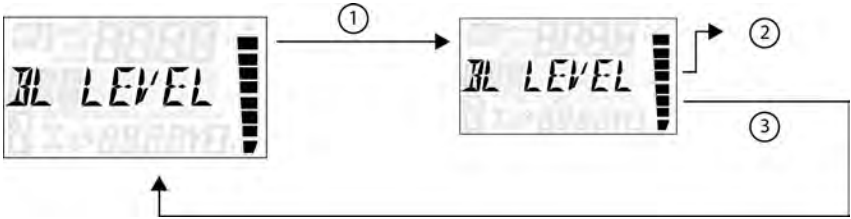

1. Press and hold the MODE button to enter the Options Menu.

### NOTICE

“OPTIONS” will display on the screen for 3 seconds before showing first menu item.

2. Select “Backlight Level” from the Options Menu by pressing the MODE button.

Reference the image shown above:

- ① Press the MODE button.
  - ② Toggle the Up/Down Buttons to change the units (Increase or Decrease Level)
  - ③ With the correct unit displayed, Press the mode button which will set the unit and return to the Options Menu.
3. To exit the Options Menu the user can select Exit Menu function from Options Menu, can hold Mode Button and exit out of Options Menu, or not press any button for 10 seconds, which will exit out of the Options Menu.

## FEATURES AND CONTROLS

### SERVICE HOURS

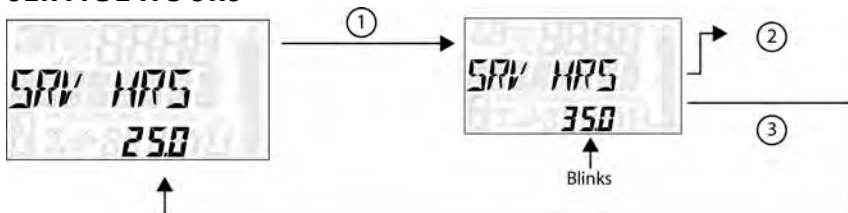

1. Press and hold the MODE button to enter the Options Menu.

#### **NOTICE**

"OPTIONS" will display on the screen for 3 seconds before showing first menu item.

2. Select "Service Hours" from the Options Menu by pressing the MODE button.  
Reference the image shown above:

- ① Press the MODE button.
- ② Toggle the Up/Down Buttons to change the units (0, 5, 10 - 95, 100)
- ③ With the correct unit displayed, press the MODE button, which will set the unit and return you to the Options Menu.

#### **NOTICE**

To reset service hours after they have counted down to "0.0", reselect the existing setpoint or select a new service hour value.

3. To exit the Options Menu the user can select Exit Menu function from Options Menu, can hold Mode Button and exit out of Options Menu, or not press any button for 10 seconds, which will exit out of the Options Menu.



**DIAGNOSTIC CODE**

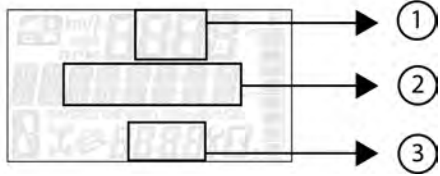

**NOTICE**

Diagnostic Code Screen will show available MIL that has come on during that ignition cycle.

1. Press and hold the MODE button to enter the Options Menu.

**NOTICE**

“OPTIONS” will display on the screen for 3 seconds before showing first menu item.

2. Select “Diagnostic Codes” from the Options Menu by pressing the MODE button.

Toggle the Up/Down Buttons to cycle through Code(s).

**NOTICE**

This option will only be available if a fault code was set or is active during the current ignition key 'on' cycle. Turning off the ignition will clear any save fault codes from the gauge.

Reference the image shown above:

- ① Area A will Display FMI (XX)
- ② Area B will Display SPN (XXXXXXX)
- ③ Clock Area will Display Count (XXX)

3. To exit the Options Menu the user can select Exit Menu function from Options Menu, can hold Mode Button and exit out of Options Menu, or not press any button for 10 seconds, which will exit out of the Options Menu.

## FEATURES AND CONTROLS

---

### DIAGNOSTIC DISPLAY CODE DEFINITIONS

**Open Load:** There is a break in the wires that lead to the item listed in the chart (injector, fuel pump, etc.), or the item has failed.

**Short-to-Ground:** The wire is shorted to ground between the electronic control unit and the item listed in the chart.

**Shorted Load:** The wires leading to the item listed in the chart are shorted together, or the item has shorted internally.

**Short-to-Battery:** The wire leading from the item listed in the chart to the electronic control unit is shorted to a wire at battery voltage.

DIAGNOSTIC CODES			
COMPONENT	CONDITION	SPN	FMI
Throttle Position Sensor	Voltage Too High	51	3
	Voltage Too Low	51	4
Engine Temperature Sensor	Voltage Too High	110	3
	Voltage Too Low	110	4
	Temperature Too High	110	16
	Engine Overheat Shutdown	110	0
Intake Air Temperature Sensor	Voltage Too High	105	3
	Voltage Too Low	105	4
Manifold Absolute Pressure Sensor	Voltage Too High	102	3
	Voltage Too Low	102	4
	Signal Out of Range	102	2
Crankshaft Position Sensor	Circuit Fault	636	8
	Plausibility Fault	636	2
Vehicle Speed Signal	Speed Too High	84	8
	Plausibility Fault	84	2
Gear Sensor Signal	Voltage Too Low	523	4
	Voltage Too Low	523	3
	Signal Fault	523	2

# FEATURES AND CONTROLS

DIAGNOSTIC CODES			
COMPONENT	CONDITION	SPN	FMI
Injector 1 (MAG) (SDI Part Load)	Driver Circuit Open/ Grounded	651	5
	Driver Circuit Short to B+	651	3
	Driver Circuit Grounded	651	4
Injector 2 (PTO) (SDI Part Load)	Driver Circuit Open/ Grounded	652	5
	Driver Circuit Short to B+	652	3
	Driver Circuit Grounded	652	4
Ignition Coil Primary Driver 1 (MAG)	Driver Circuit Short to B+	1268	3
Ignition Coil Primary Driver 2 (PTO)	Driver Circuit Short to B+	1269	3
Fuel Pump Driver Circuit	Driver Circuit Open/ Grounded	1347	5
	Driver Circuit Short to B+	1347	3
	Driver Circuit Grounded	1347	4
Fan Relay Driver Circuit	Driver Circuit Open/ Grounded	1071	5
	Driver Circuit Short to B+	1071	3
	Driver Circuit Grounded	1071	4
Idle Air Control	Driver Circuit Open/ Grounded	634	5
	Driver Circuit Short to B+	634	3
	Driver Circuit Grounded	634	4
	Position Out of Range	634	7
Starter Enable Circuit	Driver Circuit Open/ Grounded	1321	5

## FEATURES AND CONTROLS

DIAGNOSTIC CODES			
COMPONENT	CONDITION	SPN	FMI
	Driver Circuit Short to B+	1321	3
	Driver Circuit Grounded	1321	4
Chassis Relay	Driver Circuit Open/ Grounded	520208	5
	Driver Circuit Short to B+	520208	3
	Driver Circuit Grounded	520208	4
All Wheel Drive Control	Driver Circuit Open/ Grounded	520207	5
	Driver Circuit Short to B+	520207	3
	Driver Circuit Grounded	520207	4
System Power	Voltage Too High	168	3
	Voltage Too Low	168	4
Throttle Safety Signal	Voltage Too High	520194	3
	Voltage Too Low	520194	4
	Signal Out of Range	520194	2
	Throttle Stuck	520194	7
Active Descent Control System	Driver Circuit Open/ Grounded	520203	5
	Driver Circuit Short to B+	520203	3
	Driver Circuit Grounded	520203	4
Idle Speed	Speed Too High	520211	3
	Speed Too Low	520211	4

# FEATURES AND CONTROLS

DIAGNOSTIC CODES			
COMPONENT	CONDITION	SPN	FMI
<b>EPS MODELS ONLY</b>			
Vehicle Speed Sensor	Data Valid But Above Normal Operational Range - Most Severe Level	84	0
	Data Erratic, Intermittent Or Incorrect	84	2
	Abnormal Rate Of Change	84	10
	Received Network Data In Error	84	19
System Power	Data Valid But Above Normal Operational Range - Most Severe Level	168	0
	Voltage Above Normal, Or Shorted To High Source	168	3
	Voltage Below Normal, Or Shorted To Low Source	168	4
Engine Speed	Data Valid But Above Normal Operational Range - Most Severe Level	190	0
	Data Erratic, Intermittent Or Incorrect	190	2
	Received Network Data In Error	190	19
ECU Memory	Bad Intelligent Device Or Component	628	12
	Out Of Calibration	628	13
Calibration	Out Of Calibration	630	13
Steering Over Current Shut Down	Current Above Normal Or Grounded Circuit	520221	6
Steering Excessive Current Error	Current Above Normal Or Grounded Circuit	520222	6

# FEATURES AND CONTROLS

DIAGNOSTIC CODES			
COMPONENT	CONDITION	SPN	FMI
EPS MODELS ONLY			
Steering Torque Partial Failure	Condition Exists	520223	31
Steering Torque Full Failure	Condition Exists	520224	31
EPAS Inverter Temperature	Data Valid But Above Normal Operational Range - Most Severe Level	520225	0
	Data Valid But Above Normal Operating Range - Moderately Severe Level	520225	16
EPAS Communications Receive Data Error	Data Erratic, Intermittent Or Incorrect	520226	2
	Condition Exists	520226	31
Position Encoder Error	Root Cause Not Known	520228	11
	Bad Intelligent Device Or Component	520228	12
	Condition Exists	520228	31
EPAS Software Error	Bad Intelligent Device Or Component	520229	12
	Condition Exists	520229	31
EPAS Power Save Condition	Condition Exists	520231	31
EPS SEPIC Voltage Error	Voltage Above Normal, Or Shorted To High Source	524086	3
	Voltage Below Normal, Or Shorted To Low Source	524086	4

---

## OPERATION

### **WARNING**

Failure to operate the vehicle properly can result in a collision, loss of control, accident or rollover, which may result in serious injury or death. Read and understand all safety warnings outlined in the safety section of this owner's manual.

## VEHICLE BREAK-IN PERIOD

The break-in period for your new POLARIS vehicle is the first 25 hours of operation, or the time it takes to use the first two tanks full of gasoline. No single action on your part is as important as a proper break-in period. Careful treatment of a new engine and drive components will result in more efficient performance and longer life for these components. Perform the following procedures carefully.

### **NOTICE**

Excessive heat build-up during the first three hours of operation will damage close-fitted engine parts and drive components. Do not operate at full throttle or high speeds during the first three hours of use.

Use of any improper oils may cause serious engine damage. POLARIS PS-4 Full Synthetic 5W-50 4-Cycle Oil is specifically formulated for your 4-cycle engine.

### **ENGINE AND DRIVETRAIN BREAK-IN**

1. Fill the fuel tank with gasoline. See the Fuel Tank section for details. Always exercise extreme caution whenever handling gasoline.
2. Check the oil level. See the Oil Check section for reference. Add the recommended oil as needed to maintain the oil level in the safe operating range.
3. Drive slowly at first. Select an open area that allows room to familiarize yourself with vehicle operation and handling.
4. Avoid aggressive use of the brakes.
5. Vary throttle positions. Do not operate at sustained idle.
6. Pull only light loads.
7. Perform regular checks on fluid levels, controls and areas outlined on the daily pre-ride inspection checklist.
8. During the break-in period, change both the oil and the filter at 25 hours or one month.
9. Check fluid levels of transmission and all gearcases after the first 25 hours of operation and every 100 hours thereafter.

### **BRAKE SYSTEM BREAK-IN**

Apply only moderate braking force for the first 50 stops. Aggressive or overly forceful braking when the brake system is new could damage brake pads and rotors.

### **PVT BREAK-IN (CLUTCHES/BELT)**

A proper break-in of the clutches and drive belt will ensure a longer life and better performance. Break in the clutches and belt by operating at slower speeds during the break-in period as recommended. Pull only light loads. Avoid aggressive acceleration and high speed operation during the break-in period.

If a belt fails, always clean any debris from the PVT intake and outlet duct and from the clutch and engine compartments when replacing the belt.



## PRE-RIDE CHECKLIST

Failure to inspect and verify that the ATV is in safe operating condition before operating increases the risk of an accident. Always inspect the ATV before each use to make sure it's in safe operating condition.

ITEM	REMARKS	PAGE
Brake system/lever travel	Ensure proper operation	page 41 page 115
Brake fluid	Ensure proper level	page 44
Auxiliary brake	Ensure proper operation	page 44
Front suspension	Inspect, lubricate if necessary	-
Rear suspension	Inspect, lubricate if necessary	-
Steering	Ensure free operation	-
Tires	Inspect condition and pressure	page 117
Wheels/fasteners	Inspect, ensure fastener tightness	-
Frame nuts, bolts, fasteners	Inspect, ensure tightness	-
Fuel and oil	Ensure proper levels	page 165
Coolant level	Ensure proper level	page 113
Coolant hoses	Inspect for leaks	-
Throttle	Ensure proper operation	page 40
Indicator lights/switches	Ensure operation	page 53
Engine stop switch	Ensure proper operation	page 38
Air filter, pre-filter	Inspect, clean	page 121
Headlamp	Check operation	page 37
Brake light/taillight	Check operation	-
Riding gear	Wear approved helmet, goggles, and protective clothing	page 11
Winch (if equipped)	Inspect cable and switch	page 91

### **SAFE OPERATION PRACTICES**

1. Visit the Recreational Off-Highway Vehicle Association web site and take the free on-line training course. Complete the recommended safety training before operating this vehicle. Visit [www.rohva.org](http://www.rohva.org) or call 866-267-2751.
2. Do not allow anyone under 16 years of age or without a valid driver's license to operate this vehicle.
3. Never carry a passenger on this vehicle.
4. Engine exhaust fumes are poisonous. Never start the engine or let it run in an enclosed area.
5. Never operate with accessories not approved by POLARIS for use on this vehicle.
6. Operate this vehicle off-road only. Never operate this vehicle on any public street, road or highway, including dirt and gravel roads (unless designated for off-highway use).
7. Use caution and drive at reduced speeds in conditions of reduced visibility such as fog, rain and darkness. Clean headlights frequently and replace burned out headlamps promptly.
8. Always operate at a speed that's appropriate for the terrain, the visibility and operating conditions and your skills and experience. Never operate at excessive speeds. Never attempt wheelies, jumps, or other stunts. Keep both hands on the steering wheel or handlebars during operation.
9. Never consume alcohol or drugs before or while operating this vehicle.
10. Always use the size and type of tires specified for your vehicle. Always maintain proper tire pressure.
11. Never operate a damaged vehicle. After any rollover or accident, have a qualified service dealer inspect the entire machine for possible damage.
12. Never operate the vehicle on a frozen body of water unless you have first verified that the ice is sufficiently thick to support the weight and moving force of the vehicle, you and your cargo, together with any other vehicles in your party.
13. Do not touch hot exhaust system components. Always keep combustible materials away from the exhaust system.
14. Always remove the ignition key when the vehicle is not in use to prevent unauthorized use.

## TRAIL ETIQUETTE

Always practice good etiquette when riding. Allow a safe distance between your vehicle and other vehicles operating in the same area. Communicate to oncoming operators by signaling the number of vehicles in your group. When stopping, move your vehicle to the edge of the trail as far as possible to allow others to pass safely.

## KNOW YOUR RIDING AREA/TREAD LIGHTLY

Familiarize yourself with all laws and regulations concerning the operation of this vehicle in your area. Respect the environment in which you ride your vehicle. Find out where the designated riding areas are by contacting your POLARIS dealer, a local riding club, or local officials.

Help keep our trails open for recreational vehicle use. As an off-road enthusiast, you represent the sport and can set a good example (or a poor example) for others to follow. Tread lightly. Operate with respect for the terrain, avoid littering, and always stay on the designated trails.

## STARTING THE ENGINE

1. Position the vehicle on a level surface outdoors or in a well-ventilated area.
2. Place the transmission in PARK.
3. Lock the parking brake.

### TIP

The starter interlock will prevent the engine from starting if the transmission is in gear and the brake is not engaged.

4. Sit on the vehicle and move the engine stop switch to RUN.

### TIP

Do not press the throttle while starting the engine.

5. Turn the ignition key past the ON position to engage the starter. Activate the starter for a maximum of five seconds, releasing the key when the engine starts.
6. If the engine does not start, return the key to the OFF position and wait five seconds before attempting to start again. Activate the starter for another five seconds if necessary. Repeat this procedure until the engine starts.

### NOTICE

Operating the vehicle immediately after starting could cause engine damage. Allow the engine to warm up for several minutes before operating the vehicle.

## OPERATION

---

### **COLD WEATHER OPERATION**

If the vehicle is used year-round, check the oil level frequently. A rising oil level could indicate the accumulation of contaminants such as water or excess fuel in the bottom of the crankcase. Water in the bottom of the crankcase can lead to engine damage and must be drained. Water accumulation increases as outside temperature decreases.

### **NEW OPERATOR DRIVING PROCEDURES**

1. Wear protective riding gear. See the Safe Riding Gear section.
2. Perform the pre-ride inspection.
3. Place the transmission in PARK.
4. Lock the parking brake.
5. Mount the vehicle from the left side.
6. Sit upright with both feet on the footrests and both hands on the handlebars.
7. Start the engine and allow it to warm up.
8. Shift the transmission into gear.
9. Check your surroundings and determine your path of travel.
10. Release the parking brake.
11. Slowly depress the throttle with your right thumb and begin driving.
12. Drive slowly. Practice maneuvering and using the throttle and brakes on level surfaces.

## TURNING THE VEHICLE

Both rear wheels drive equally at all times. This means that the outside wheel must travel a greater distance than the inside wheel when turning, and the inside tire must slip traction slightly.

1. Slow down.
2. Never turn quickly when carrying cargo.
3. Steer in the direction of the turn.
4. Keep both feet on the footrests.
5. Lean your upper body to the inside of the turn while supporting your weight on the outer footrest. This technique alters the balance of traction between the rear wheels, allowing the turn to be made smoothly. The same leaning technique should be used for turning in reverse.
6. Practice making turns at slow speeds before attempting to turn at faster speeds

### WARNING

Turning improperly can result in vehicle overturn. Never turn abruptly or at sharp angles. Never turn at high speeds.

## TURNING AROUND ON A HILL (K-TURN)

If the vehicle stalls while climbing a hill, never back it down the hill! Use the K-turn to turn around.

1. Stop and lock the parking brake while keeping body weight uphill.
2. Always move the 4X4 switch to ADC 4X4 before ascending or descending a hill. See the Switch Location section for details.
3. Leave the transmission in forward and shut off the engine.
4. Dismount on the uphill side of the vehicle, or on the left if the vehicle is pointing straight uphill.
5. Staying uphill of the vehicle, turn the handlebars full left.
6. While holding the brake lever, release the parking brake lock and slowly allow the vehicle to roll around to your right until it's pointing across the hill or slightly downward.
7. Lock the parking brake. Remount the vehicle from the uphill side, keeping body weight uphill. Start the engine with the transmission still in forward.
8. Release the parking brake and proceed *slowly*, controlling speed with the brake lever, until the vehicle is on more level ground.

## OPERATION

---

### DRIVING ON SLIPPERY SURFACES

Whenever riding on slippery surfaces such as wet trails or loose gravel, or during freezing weather, follow these precautions:

1. Do not operate on excessively rough, slippery or loose terrain.
2. Slow down when entering slippery areas.
3. Engage 4X4 before wheels begin to lose traction.

#### **NOTICE**

Severe damage to drive train may occur if the 4X4 is engaged while the wheels are spinning. Allow the rear wheels to stop spinning before engaging 4X4, or engage 4X4 before wheels begin to lose traction.

4. Maintain a high level of alertness, reading the trail and avoiding quick, sharp turns, which can cause skids.
5. Never apply the brakes during a skid. Correct a skid by turning the handlebars in the direction of the skid and shifting your body weight forward.

## DRIVING THROUGH WATER



Your ATV can operate through water with a maximum recommended depth equal to the bottom of the footrests. Follow these procedures when operating through water:

1. Determine water depths and current before entering water.
2. Choose a crossing where both banks have gradual inclines.
3. Avoid operating through deep or fast-flowing water.

### NOTICE

Major engine damage can result if the vehicle is not thoroughly inspected after operation in water. Perform the services outlined in the Periodic Maintenance Chart. The following areas need special attention: engine oil, transmission oil, demand drive fluid and all grease fittings.

If the vehicle tips or overturns in water, or if the engine stops during or after operating in water, service is required before starting the engine. Your POLARIS dealer can provide this service. If it's impossible to bring the vehicle in before starting the engine, perform the service outlined in the Vehicle Immersion section of this manual, and take the vehicle in for service at the first opportunity.

## OPERATION

---

4. After leaving water, test the brakes. Apply them lightly several times while driving slowly. The friction will help dry out the pads.

*If it's unavoidable to enter water deeper than the footrest level:*

- Proceed slowly. Avoid rocks and obstacles.
- Balance your weight carefully. Avoid sudden movements.
- Maintain a steady rate of speed. Do not make sudden turns or stops. Do not make sudden throttle changes.

## DRIVING OVER OBSTACLES

Follow these precautions when operating over obstacles:



1. Always check for obstacles before operating in a new area.
2. Look ahead and learn to read the terrain. Be constantly alert for hazards such as logs, rocks and low hanging branches.
3. Travel slowly and use extra caution when operating on unfamiliar terrain. Not all obstacles are immediately visible.
4. Never attempt to operate over large obstacles, such as rocks or fallen trees.
5. Always have a passenger dismount before operating over an obstacle that could cause a fall from the vehicle or vehicle tipover.



## DRIVING UPHILL

Braking and handling are greatly affected when operating in hilly terrain. Improper procedure could cause loss of control or rollover. Whenever traveling uphill, follow these precautions:

1. Always move the 4X4 switch to ADC 4X4 (if equipped) before ascending or descending a hill. See page 47. Never operate in TURF mode while operating on a hill or other irregular terrain.
2. Drive straight uphill.
3. Avoid steep hills. Maximum incline is:
  - 15° (Touring/X2)
  - 25° (1-Up Models)
4. Always check the terrain carefully before ascending any hill.
5. Never climb hills with excessively slippery or loose surfaces.
6. Keep both feet on the footrests.
7. Shift body weight uphill. A passenger should also shift body weight uphill.
8. Proceed at a steady rate of speed and throttle opening. Opening the throttle suddenly could cause the ATV to flip over backwards.
9. Never go over the top of any hill at high speed. An obstacle, a sharp drop, or another vehicle or person could be on the other side of the hill.
10. Remain alert and be prepared to take emergency action. This may include quick dismounting of the vehicle.



Touring/X2  
15°



1-Up Models  
25°

## OPERATION

---

### DRIVING DOWNHILL

When driving downhill, follow these precautions:

1. Always move the 4X4 switch to ADC 4X4 (if equipped) before ascending or descending a hill. Never operate in TURF mode while operating on a hill or other irregular terrain.
2. Avoid steep hills. Maximum incline is:
  - 15° (Touring/X2)
  - 25° (1-up Models)
3. Always check the terrain carefully before descending a hill.
4. Always descend a hill with the transmission in forward gear. Do not descend a hill with the transmission in neutral.
5. Slow down. Never travel down a hill at high speed.
6. Drive straight downhill. Avoid traveling down a hill at an angle, which would cause the vehicle to lean sharply to one side.
7. Shift body weight uphill. A passenger should also shift body weight uphill.
8. Apply the brakes *slightly* to aid in slowing. Applying the brakes too firmly may cause the rear wheels to lock, which could result in loss of control.



Touring/X2  
15°



1-Up Models  
25°

---

## DRIVING ON A SIDEHILL (SIDEHILLING)

Driving on a sidehill is not recommended. Improper procedure could cause loss of control or overturn. Avoid crossing the side of any hill unless absolutely necessary.



If crossing a sidehill is *unavoidable*, follow these precautions:

1. Slow down.
2. Avoid crossing the side of a steep hill.
3. Lean into the hill, transferring your upper body weight toward the hill while keeping your feet on the footrests.
4. If the vehicle begins to tip, quickly turn the front wheel downhill, if possible, or dismount on the uphill side *immediately!*

## OPERATION

---

### DRIVING IN REVERSE

Follow these precautions when operating in reverse:



1. Always check for obstacles or people behind the vehicle.
2. Always avoid backing downhill.
3. Back slowly.
4. Apply the brakes *lightly* for stopping.
5. Avoid turning at sharp angles.
6. Never open the throttle suddenly.
7. Do not use the override switch unless additional wheel speed is required for vehicle movement. Use the override with caution as rearward vehicle speed is greatly increased. Do not operate at wide open throttle. Operate the throttle just enough to maintain a desired speed.

#### **NOTICE**

Excessive throttle operation while in the speed limit mode may cause fuel to build in the exhaust, resulting in engine popping and/or engine damage.

---

## PARKING ON AN INCLINE

Avoid parking on an incline if possible. If it's unavoidable, follow these precautions:

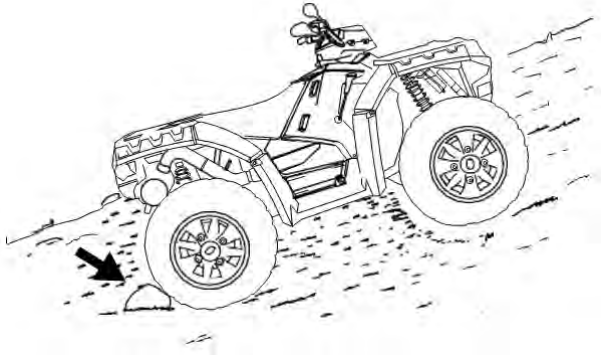

1. Stop the engine.
2. Place the transmission in PARK.
3. Lock the parking brake.
4. Always block the rear wheels on the downhill side.

## OPERATION

---

### STOPPING THE ENGINE

1. Release the throttle pedal completely and brake to a complete stop.
2. Place the transmission in PARK.
3. Turn the engine off.
4. Slowly release the brake pedal and make sure the transmission is in PARK before exiting the vehicle.

#### **WARNING**

A rolling vehicle can cause serious injury. Always place the transmission in PARK when stopping the engine.

### BRAKING

1. Release the throttle pedal completely. (When the throttle pedal is released completely and engine speed slows to near idle, the vehicle has no engine braking.)
2. Press on the brake pedal evenly and firmly. Practice starting and stopping (using the brakes) until you're familiar with the controls.

### PARKING THE VEHICLE

1. Stop the vehicle on a level surface. When parking inside a garage or other structure, be sure that the structure is well ventilated and that the vehicle is not close to any source of flame or sparks, including any appliance with pilot lights.
2. Place the transmission in PARK.
3. Turn the engine off.
4. Engage the parking brake (if equipped).
5. Slowly release the brake pedal and make sure the transmission is in PARK before exiting the vehicle.
6. Remove the ignition key to prevent unauthorized use.

## HAULING CARGO

### CARGO WARNING

#### WARNING

Overloading the vehicle or carrying or towing cargo improperly can alter vehicle handling and may cause loss of control or brake instability, which can result in serious injury or death. Always follow these precautions when hauling cargo:

**REDUCE SPEED AND ALLOW GREATER DISTANCES FOR BRAKING WHEN HAULING CARGO.**

**NEVER EXCEED THE MAXIMUM WEIGHT CAPACITY** of the vehicle. When determining the weight you are adding to the vehicle, include the weight of the operator, accessories, loads in the rack or box and the load on the trailer tongue. The combined weight of these items must not exceed the maximum weight capacity.

**CARGO WEIGHT DISTRIBUTION** should be 1/3 on the front rack and 2/3 on the rear rack. When operating over rough or hilly terrain, reduce speed and cargo to maintain stable driving conditions. Carrying loads on only one rack increases the possibility of vehicle overturn.

**CARRY LOADS AS LOW ON THE RACKS AS POSSIBLE.** Carrying loads high on the racks raises the center of gravity of the vehicle and creates a less stable operating condition.

**SECURE ALL LOADS BEFORE OPERATING.** Unsecured loads can create unstable operating conditions, which could result in loss of control of the vehicle.

**OPERATE ONLY WITH STABLE AND SAFELY ARRANGED LOADS.** When handling off-centered loads that cannot be centered, securely fasten the load and operate with extra caution. Always attach the tow load to the hitch point designated for your vehicle.

**HEAVY LOADS CAN CAUSE BRAKING AND CONTROL PROBLEMS.** Use extreme caution when applying brakes with a loaded vehicle. Avoid terrain or situations that may require backing downhill.

**USE EXTREME CAUTION** when operating with loads that extend over the rack sides. Stability and maneuverability may be adversely affected, causing the vehicle to overturn.

**DO NOT BLOCK THE FRONT HEADLIGHT BEAM** when carrying loads on the front rack.

**DO NOT TRAVEL FASTER THAN THE RECOMMENDED SPEEDS.**

The vehicle should never exceed 10 mph (16 kph) while towing a load on a level surface. Vehicle speed should never exceed 5 mph (8 kph) when towing loads in rough terrain, while cornering, or while ascending or descending a hill.

## OPERATION

---

### HAULING CARGO GUIDELINES

When hauling cargo, adhere to the following:

1. Never exceed the weight capacities specified for your ATV on warning labels and in the specifications section of this manual.
2. **X2 Model:** Always load a cargo box with the load as far forward as possible. NEVER exceed 10 MPH (16 km/h) when rear cargo loads are above 200 lbs. (91 kg) and/or front cargo loads are 90 lbs. (41 kg). Make sure the cargo box dump latch is securely latched before loading and operating. Unintentional dumping will result if weight is placed in the rear of the box and the latch is not secured.
3. **Models With Racks:** Cargo weight should be evenly distributed with 1/3 on the front rack and 2/3 on the rear rack and mounted as low as possible.
4. **All Models:** NEVER exceed 50 MPH (80 km/h) when rear cargo loads are above 75 lbs. (34 kg) and/or front cargo loads are above 37 lbs. (17 kg).  
**2-Up Models:** NEVER exceed 50 MPH (80 km/h) while carrying a passenger.
5. When operating over rough or hilly terrain, reduce speed and cargo weight to maintain stable driving conditions.
6. Do not obstruct the headlight beam with cargo.
7. Use low forward gear when hauling or towing heavy cargo.
8. Always operate the vehicle with extreme caution whenever hauling or towing loads. Balance, handling and control may be affected.

### TOWING LOADS

Always attach a towed load to the hitch point. Remove the hitch from the ATV when not towing a trailer. If towing a load, reduce rear rack cargo weight by the amount of tongue weight.

- The combination of rear rack cargo weight and tongue weight must not exceed the rear rack capacity.
- The total load (operator, accessories, cargo and weight on hitch) must not exceed the maximum weight capacity of the vehicle.

#### NOTICE

Using an improper hitch or exceeding the maximum tongue weight capacity can result in serious damage to the vehicle and will void your ATV warranty.

Never install a hitch longer than 4" (10 cm). Never install automotive accessories on your POLARIS ATV. Always install POLARIS-approved (or equivalent) accessories designed for ATV use.



**MAXIMUM TOWING CAPACITIES**

Do not exceed maximum towing capacities. Avoid towing on inclines.

MODEL	CAPACITIES	FRONT HITCH	REAR HITCH
450 HO 450 HO EPS 570 570 EPS 570 Touring 570 Touring EPS 570 X2 EPS	Maximum Towed Load (Level Ground)	NA	1225 lbs (555 kg)
	Maximum Vertical Hitch Weight	NA	120 lbs (55 kg)
450 HD 2X4	Maximum Towed Load (Level Ground)	NA	
	Maximum Vertical Hitch Weight	NA	
450 Utility Edition 570 Utility Edition	Maximum Towed Load (Level Ground)	850 lbs (386 kg)	1225 lbs (555 kg)
	Maximum Vertical Hitch Weight	85 lbs (39 kg)	120 lbs (55 kg)
570 SP 570 Touring SP	Maximum Towed Load (Level Ground)	NA	1500 lbs (680 kg)
	Maximum Vertical Hitch Weight	NA	150 lbs (68 kg)
570 HD	Maximum Towed Load (Level Ground)	NA	
	Maximum Vertical Hitch Weight	NA	
570 UTE	Maximum Towed Load (Level Ground)	NA	
	Maximum Vertical Hitch Weight	NA	

### CARGO BOX DUMPING (IF EQUIPPED)

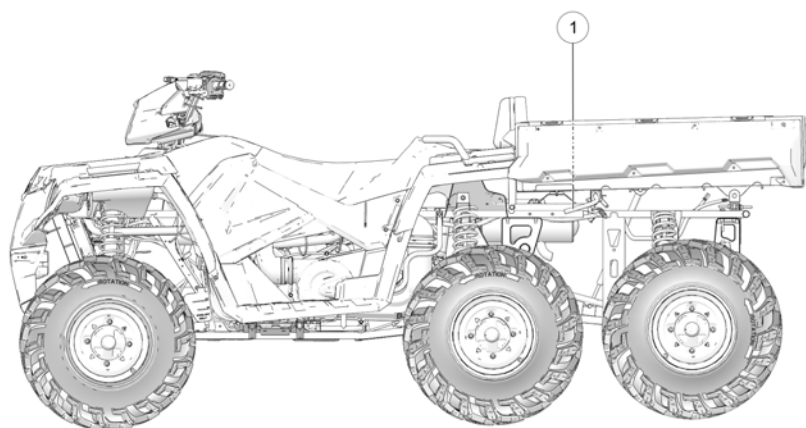

#### NOTE

Sportsman® 6x6 570 shown for reference only.

1. Select a level site to dump the cargo box. Do not attempt to dump or unload the vehicle while parked on an incline.
2. Place the transmission in PARK. Lock the parking brake.
3. Dismount the vehicle.
4. Lower the tailgate.

#### WARNING

If cargo weight is placed toward the rear of the cargo box, the load may dump unexpectedly and cause serious injury. When loading cargo, always position the weight as far forward and as low as possible.

5. Pull the cargo box release lever ① upward.
6. Lift the front of the cargo box and dump the cargo.

7. Lower the cargo box and make sure the release latch is secured.

**⚠ WARNING**

To prevent a crushing injury to hands and fingers, keep hands and fingers away from the lower front edge of the cargo box while lowering the box.

8. Secure the tailgate.

**⚠ WARNING**

Operating with the cargo box in the raised position can cause serious injury and damage to the vehicle. The cargo box could close unexpectedly and injure the driver. The rear tires will also catch the rear of the bed, damaging the vehicle and creating hazardous driving conditions. Never operate this vehicle with the cargo box in the raised position.

## TOWING YOUR VEHICLE

If towing your vehicle is necessary, shift the transmission into neutral for better mobility and to prevent damage to the belt. Always attach the tow cable to the front tow loop of the disabled vehicle. A rider must be on board to steer the disabled vehicle while towing.

## TRAILERING YOUR VEHICLE

Follow these procedures when transporting the vehicle.

1. Stop the engine.
2. Place the transmission in PARK.
3. Secure the fuel cap, oil cap, and seat.
4. Remove the key to prevent loss during transporting.
5. Always tie the frame of the vehicle to the transporting unit securely with suitable straps or rope. Do not attach tie straps to the front A-arm bolt pockets, racks, or handlebars.



---

## WINCH GUIDE

These safety warnings and instructions apply if your vehicle came equipped with a winch or if you choose to add an accessory winch to your vehicle.

### **WARNING**

Improper winch use can result in **SEVERE INJURY** or **DEATH**. Always follow all winch instructions and warnings in this manual.

Your winch may have a cable made of either wire rope or specially designed synthetic rope. The term “winch cable” will be used for either unless noted otherwise.

## WINCH SAFETY PRECAUTIONS

1. Read all sections of this manual.
2. Never use alcohol or drugs before or while operating the winch.
3. Never allow children under 16 years of age to operate the winch.
4. Always wear eye protection and heavy gloves when operating the winch.
5. Always keep body, hair, clothing and jewelry clear of the winch cable, fairlead and hook when operating winch.
6. Never attempt to “jerk” a load attached to the winch with a moving vehicle. See the *Shock Loading* section on page 99.
7. Always keep the area around the vehicle, winch, winch cable, and load clear of people (especially children) and distractions while operating the winch.
8. Always turn the vehicle ignition power OFF when it and the winch are not being used.
9. Always be sure that at least five (5) full turns of winch cable are wrapped around the winch drum at all times. The friction provided by this wrapped cable allows the drum to pull on the winch cable and move the load.
10. Always apply your vehicle’s park brake and/or park mechanism to hold the vehicle in place during winching. Use wheel chocks if needed.
11. Always align the vehicle and winch with the load directly in front of the vehicle as much as possible. Avoid winching with the winch cable at an angle to the winching vehicle’s centerline whenever possible.
12. If winching at an angle is unavoidable, follow these precautions:
  - a. Look at the winch drum occasionally. Never let the winch cable “stack” or accumulate at one end of the winch drum. Too much winch cable at one end of the winch drum can damage the winch and the winch cable.

## WINCH GUIDE

---

- b. If stacking occurs, stop winching. Follow step 15 of Winch Operation to feed and rewind the cable evenly before continuing the winch operation.
- 13. Never winch up or down at sharp angles. This can destabilize the winching vehicle and possibly cause it to move without warning.
- 14. Never attempt to winch loads that weigh more than the winch's rated capacity.
- 15. The winch motor may become hot during winch use. If you winch for more than 45 seconds, or if the winch stalls during operation, stop winching and permit the winch to cool down for 10 minutes before using it again.
- 16. Never touch, push, pull or straddle the winch cable while winching a load.
- 17. Never let the winch cable run through your hands, even if wearing heavy gloves.



- 18. Never release the clutch on the winch when the winch cable is under load.
- 19. Never use the winch for lifting or transporting people.
- 20. Never use the winch to hoist or suspend a vertical load.
- 21. Never immerse or submerge your winch in water. Your dealer can provide service on your winch if this occurs.
- 22. Always inspect your winch and winch cable before each use.
- 23. Never winch the hook fully into the winch. This can cause damage to winch components.
- 24. Unplug the remote control from the vehicle when the winch is not in use to prevent inadvertent activation and use by unauthorized persons.
- 25. Never grease or oil the winch cable. This will cause the winch cable to collect debris that will shorten the life of the cable.

## WINCH OPERATION

Read the Winch Safety Precautions in the preceding pages before using your winch.

### TIP

Consider practicing the operation and use of your winch before you actually need to use it in the field.

### WARNING

Improper winch use can result in SEVERE INJURY or DEATH. Always follow all winch instructions and warnings in this manual.

Each winching situation is unique.

- Take your time to think through the winching you are about to do.
- Proceed slowly and deliberately.
- Never hurry or rush during winching.
- Always pay attention to your surroundings.
- You may need to change your winching strategy if it is not working.
- Always remember that your winch is very powerful.
- There are simply some situations that you and your winch will not be able to deal with. Do not be afraid to ask others to help when this happens.

1. Always inspect the vehicle, winch, winch cable and winch controls for any signs of damage or parts in need of repair or replacement before each use. *Pay particular attention to the first 3 feet (1 meter) of winch cable if the winch is being used (or has been used) for lifting an accessory plow assembly.* Promptly replace any worn or damaged cable.
2. Never operate a winch or a vehicle in need of repair or service.
3. Always apply your vehicle's park brake and/ or park mechanism to hold the vehicle in place during winching. Use wheel chocks if needed.

## WINCH GUIDE

4. Always use the hook strap when handling the hook.

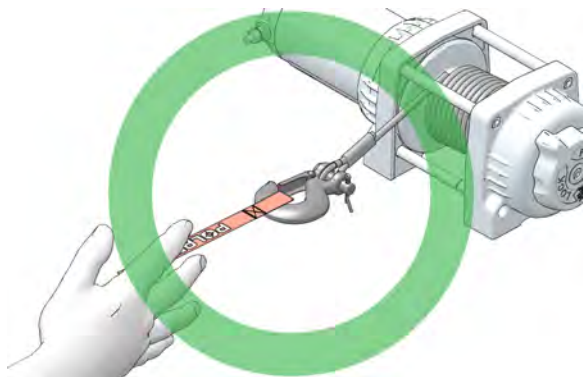

### **⚠ WARNING**

Never put your fingers into the hook. This could lead to SEVERE INJURY.

- Attach the hook itself onto the load or use a tow strap or chain to secure the load to the winch cable.



### **TIP**

A “tow strap” is NOT intended to stretch. A “recovery strap” is designed to stretch.

### **⚠ WARNING**

Never use a recovery strap when winching due to the excessive energy that can be released if the winch cable breaks. This can result in SEVERE INJURY or DEATH. See the *Shock Loading* section on page 99.

- Never hook the winch cable back onto itself. This will damage the winch cable and may result in winch cable failure.



**⚠ WARNING**

Replace the winch cable at the first sign of damage to prevent SEVERE INJURY or DEATH in the event of failure. For your safety, always replace POLARIS winch parts (including the cable) with genuine POLARIS replacement parts available at your authorized POLARIS dealer, or other qualified dealer.

- If possible, keep the winch cable aligned with the centerline of the winching vehicle. This will help the spooling of the winch cable and reduce the load on the fairlead.
- If freeing a stuck vehicle by attaching to a tree, use an item such as a tow strap to avoid damaging the tree during winch operation. Sharp cables and chains can damage and even kill trees. Please remember to TreadLightly® (treadlightly.org).
- Before operating the winch, be sure that the safety latch on the winch cable hook is fully seated when the load is attached.
- Never operate your winch with a damaged hook or latch. Always replace damaged parts before using the winch.

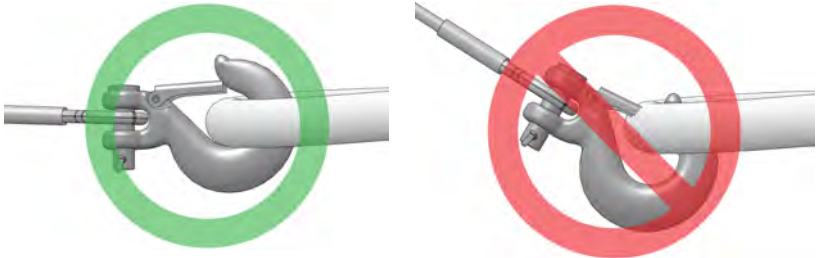

5. Never remove the hook strap from the hook.
6. Release the winch clutch and pull out the winch cable.
7. Pulling out as much cable as possible maximizes the winch's pulling capacity. Always be sure that at least five (5) full turns of winch cable are wrapped around the winch drum at all times. The friction provided by this wrapped cable allows the drum to pull on the winch cable and move the load.
8. Read and adhere to the following information for winch damping to ensure safe winch use.
  - a. In order to absorb energy that could be released by a winch cable failure, always place a "damper" on the winch cable. A damper can be heavy jacket, tarp, or other soft, dense object. A damper can absorb much of the energy released if a winch cable breaks when winching. Even a tree limb can help as a damper if no other items are available to you.

## WINCH GUIDE

---

- b. Lay the damper on top of the mid-point of the winch cable length that is spooled out.
  - c. On a long pull, it may be necessary to stop winching so that the damper can be repositioned to the new mid-point of the winch cable. Always release the tension on the winch cable before repositioning the damper.
  - d. Avoid being directly in line with the winch cable whenever possible. Also, never permit others to stand near or in line with the winch cable during winch operation.
9. Never hook the winch cable back onto itself. This will damage the winch cable and may result in winch cable failure.
10. Never use straps, chains or other rigging items that are damaged or worn.
11. The ONLY time a winch-equipped vehicle should be moving when using the winch is when that vehicle itself is stuck. The winch equipped vehicle should NEVER be in motion to “shock” load the winch cable in an attempt to move a second stuck vehicle. See the Shock Loading section on page 99. For your safety, always follow these guidelines when winching a vehicle free:
- a. Release the winch clutch and spool out the necessary length of winch cable.
  - b. Align the winch cable as close as possible to the winching vehicle’s centerline.
  - c. Attach the winch cable hook to the anchor point or the stuck vehicle’s frame following instructions in this manual.
  - d. Re-engage the clutch on the winch.
  - e. Slowly winch in the slack in the winch cable.
  - f. Select the proper vehicle gear to propel the stuck vehicle in the direction of winching.
  - g. Shift to the lowest gear available on the stuck vehicle.
  - h. Slowly and carefully apply vehicle throttle and winch together to free the vehicle.
  - i. Stop winching as soon as the stuck vehicle is able to propel itself without the help of the winch.
  - j. Detach the winch cable hook.
  - k. Rewind the winch cable evenly back onto the winch drum following the instructions in this manual.
12. Never attempt to winch another stuck vehicle by attaching the winch cable to a suspension component, brush guard, bumper or cargo rack. Vehicle damage may result. Instead, attach the winch to a strong portion of the vehicle frame or hitch.

13. Extensive winching will run down the battery on the winching vehicle. Let the winching vehicle's engine run while operating the winch to prevent the battery from running low if winching for long periods.
14. The winch motor may become hot during winch use. If you winch for more than 45 seconds, or if the winch stalls during operation, stop winching and permit the winch to cool down for 10 minutes before using it again.
15. After winching is complete, especially if winching at an angle, it may be necessary to re-distribute the winch cable across the winch drum. You will need an assistant to perform this task.
  - a. Release the clutch on the winch.
  - b. Feed out the winch cable that is unevenly bunched up in one area.
  - c. Re-engage the winch clutch.
  - d. Have an assistant pull the winch cable tightly with about 100 lbs. (45 kg) of tension using the hook strap.
  - e. Slowly winch the cable in while your assistant moves the end of the winch cable back and forth horizontally to evenly distribute the winch cable on the drum.
  - f. Doing this reduces the chances of the winch cable "wedging" itself between lower layers of winch cable.

### WINCH CABLE CARE

#### **WARNING**

Use of worn or damaged cable could lead to sudden failure and SEVERE INJURY.

For your safety, always replace POLARIS winch parts (including the cable) with genuine POLARIS replacement parts available at your authorized POLARIS dealer, or other qualified person.

1. Always inspect your winch before each use. Inspect for worn or loose parts including mounting hardware. Never use the winch if any part needs repair or replacement.
2. Always inspect your winch cable before each use. Inspect for worn or kinked winch cable.

A kinked winch cable made of wire rope is shown at right. Even after being “straightened out,” this cable has already been permanently and severely damaged. Promptly discontinue use of a winch cable in this condition.



A kinked winch cable made of wire rope that has been “straightened out” is shown at right. Even though it may look usable, the cable has been permanently and severely damaged. It can no longer transmit the load that it could prior to kinking. Promptly discontinue use of a winch cable in this condition.

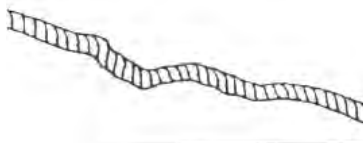

A winch cable made of synthetic rope should be inspected for signs of fraying. Replace the cable if fraying is observed (shown below). Promptly discontinue use of a winch cable in this condition. Also replace the winch cable if there are fused or melted fibers. Such an area of the synthetic rope will be stiff and appear smooth or glazed. Promptly discontinue use of a winch cable in this condition.



---

## SHOCK LOADING

### WARNING

Your winch cable is very strong but it is NOT designed for dynamic, or “shock” loading. Shock loading may tension a winch cable beyond its strength and cause the cable to break. The end of a broken winch cable under such high loading can cause SEVERE INJURY or DEATH to you and other bystanders.

*Winch cables are designed to NOT absorb energy. This is true of both wire-rope and synthetic-rope winch cables.*

1. Never attempt to “jerk” a load with the winch. For example, never take up slack in the winch cable by moving the winching vehicle in an attempt to move an object. This is a dangerous practice. It generates high winch cable loads that may exceed the strength of the cable. Even a slowly moving vehicle can create large shock loads in a winch cable.

### WARNING

SEVERE INJURY or DEATH can result from a broken winch cable.

2. Never quickly turn the winch ON and OFF repeatedly (“jogging”). This puts extra load on the winch, winch cable, and generates excessive heat from the motor. This is a form of shock loading.
3. Never tow a vehicle or other object with your winch. Towing an object with a winch produces shock loading of the cable even when towing at slow speeds. Towing from a winch also positions the towing force high on the vehicle. This can cause instability of the vehicle and possibly lead to an accident.
4. Never use recovery straps with your winch. Recovery straps are designed to stretch and can store energy. This stored energy in the recovery strap is released if a winch cable fails making the event even more hazardous. Similarly, never use elastic “bungee” cords for winching.
5. Never use the winch to tie down a vehicle to a trailer or other transportation vehicle. This type of use also causes shock loading that can cause damage to the winch, winch cable, or vehicles used.

**Your winch cable is designed and tested to withstand the loads produced by the winch motor when operated from a stationary vehicle. Always remember that the winch and winch cable are NOT designed for shock loading.**

### WINCH MAINTENANCE AND SERVICE SAFETY

#### **WARNING**

Improper or lack of winch maintenance and service could lead to **SEVERE INJURY** or **DEATH**. Always follow all winch instructions and warnings in this manual.

1. Always inspect your winch before each use. Inspect for worn or kinked winch cable. Also inspect for worn or loose parts including mounting hardware.
2. Permit your winch motor to cool down prior to servicing your winch.
3. Never work on your winch without first disconnecting the battery connections to prevent accidental activation of the winch.
4. For your safety, always replace POLARIS winch parts (including the cable) with genuine POLARIS replacement parts available at your authorized POLARIS dealer, or other qualified person.
5. Some winch models use wire rope as the winch cable. Other winches use a specially designed synthetic rope as the winch cable.
6. Never replace a synthetic-rope winch cable with a consumer-grade polymer rope such as can be purchased in a hardware store. Although they may look similar, they are **NOT** alike. A polymer rope not designed for winch use will stretch and store excessive energy when winching.

#### **WARNING**

Failure of a stretched rope under winching conditions will release all of the stored energy. This will increase the chances of **SEVERE INJURY** or **DEATH**.

### **EMISSION CONTROL SYSTEMS**

#### **NOISE EMISSION CONTROL SYSTEM**

Do not modify the engine, intake or exhaust components, as doing so may affect compliance with U.S.A. EPA noise control requirements (40 CFR 205) and local noise level requirements.

#### **OPERATION ON PUBLIC LANDS IN THE U.S.A.**

Your vehicle has a spark arrester that was tested and qualified to be in accordance with the USFS standard 5100-1C. Federal law requires that this spark arrester be installed and functional when the vehicle is operated on public lands.

Operation of off-road vehicles on public lands in the U.S.A. is regulated by 43 CFR 420. Violations are subject to monetary penalties. Federal regulations can be viewed online at [www.gpoaccess.gov/ecfr/](http://www.gpoaccess.gov/ecfr/).

#### **CRANKCASE EMISSION CONTROL SYSTEM**

This engine is equipped with a closed crankcase system. Blow-by gases are forced back to the combustion chamber by the intake system. All exhaust gases exit through the exhaust system.

#### **EXHAUST EMISSION CONTROL SYSTEM**

Exhaust emissions are controlled by engine design. An electronic fuel injection (EFI) system controls fuel delivery. The engine and EFI components are set at the factory for optimal performance and are not adjustable.

The emissions label is located on the right front frame of the vehicle.

#### **ELECTROMAGNETIC INTERFERENCE**

This spark ignition system complies with Canadian ICES-002.

This vehicle complies with the EMC requirements of UN ECE Regulation 10.

Non-ionizing Radiation: This vehicle emits some electromagnetic energy. People with active or non-active implantable medical devices (such as heart monitoring or controlling devices) should review the limitations of their device and the applicable electromagnetic standards and directives that apply to this vehicle.





## MAINTENANCE

### PERIODIC MAINTENANCE

Any qualified repair shop or person may maintain, replace or repair the emission control devices or systems on your vehicle. An authorized POLARIS dealer can perform any service that may be necessary for your vehicle. POLARIS also recommends POLARIS parts for emissions-related service, however equivalent parts can be used.

It is a potential violation of the Clean Air Act if a part supplied by an aftermarket parts manufacturer reduces the effectiveness of the vehicle's emission controls. Tampering with emission controls is prohibited by federal law.

Owners are responsible for performing the scheduled maintenance identified in this owner's manual. Careful periodic maintenance will help keep your vehicle in safe, reliable condition. Inspect, clean, lubricate, adjust and replace parts as necessary. When inspection reveals the need for replacement parts, genuine POLARIS parts are available from your POLARIS dealer. Equivalent parts may be used for emissions-related service.

Record maintenance and service in the Maintenance Log beginning on page 179. Service and adjustments are important for proper vehicle operation. If you're not familiar with safe service and adjustment procedures, a qualified dealer can perform these operations. Maintenance intervals in the following chart are based upon average riding conditions and an average vehicle speed of approximately 10 miles per hour. Vehicles subjected to severe use must be inspected and serviced more frequently.

### SEVERE USE DEFINITION

Severe use is defined as:

- Frequent immersion in mud, water, or sand
- Frequent or prolonged operation in dusty environments
- Short trip cold weather operation
- Racing or racing-style high RPM use
- Prolonged low speed, heavy load operation
- Extended idle

# MAINTENANCE

## MAINTENANCE CHART

SYMBOL	DESCRIPTION
XU	Perform these procedures more often for vehicles subjected to severe use.
D	Have an authorized Polaris dealer or other qualified person perform these services.

### WARNING

Improperly performing the procedures marked with a **D** could result in component failure and lead to serious injury or death. Have an authorized POLARIS dealer or other qualified person perform these services.

Perform all services at whichever maintenance interval is reached first. Record maintenance and service in the Maintenance Log.

ITEM	MAINTENANCE INTERVAL (WHICHEVER COMES FIRST)			REMARKS
	HOURS	CALENDAR	MILES (KM)	
Steering		Pre-Ride		Inspect and make adjustments as needed.
Front Suspension				
Rear Suspension				
Tires				
Brake Fluid Level				
Brake Lever Travel				
Brake System				
Wheels / Fasteners				
CV Boot				
Frame Fasteners				
Engine Oil Level				
Winch (if equipped)				
<b>XU</b> Air Filter (Pre-Filter)	-	Daily	-	Inspect; clean often; replace as needed
Coolant	-	Daily	-	Check level daily, change coolant every two years
Head Lights / Tail Lights	-	Daily	-	Check operation; apply dielectric grease if replacing
Power Steering unit (If equipped)	-	Daily		Inspect daily, clean often
<b>XU D</b> Brake Pad Wear	10 H	Monthly	100 (160)	Inspect periodically
Battery	20 H	Monthly	200 (320)	Check terminals; clean; test

# MAINTENANCE

ITEM		MAINTENANCE INTERVAL (WHICHEVER COMES FIRST)			REMARKS
		HOURS	CALENDAR	MILES (KM)	
	Fuel System	20 H	Monthly	-	Inspect; cycle key to pressurize fuel pump; check lines and fittings for leaks and abrasion
<b>XU</b>	Engine Oil Change	25 H	1 M	-	Break-in oil and filter change
<b>XU</b>	Demand Drive Fluid	25 H	1 M	250 (400)	Break-in fluid level check
<b>XU</b>	Rear Gearcase Oil	25 H	1 M	250 (400)	Break-in fluid level check
<b>XU</b>	Transmission Fluid	25 H	1 M	250 (400)	Break-in fluid level check
<b>XU</b>	General Lubrication	50 H	3 M	500 (800)	Lubricate all fittings, pivots, cables, etc.
	Shift Linkage	50 H	3 M	500 (800)	Inspect
<b>D</b>	Steering	50 H	6 M	500 (800)	Lubricate
<b>XU</b>	Front/Rear Suspension	50 H	6 M	500 (800)	Lubricate
<b>XU</b>	Throttle Release Switch	50 H	6 M	500 (800)	Inspect; adjust; lubricate; replace if necessary
	Throttle Body Intake Duct	50 H	6 M	500 (800)	Inspect ducts for proper sealing / air leaks
	Drive Belt	50 H	6 M	500 (800)	Inspect; replace as needed
<b>XU</b>	Air Filter (main element)	50 H	6 M	500 (800)	Inspect; replace as needed
	Cooling System	50 H	6 M	1000 (1600)	Inspect coolant strength seasonally; pressure test system yearly
<b>XU</b>	Radiator	50 H	6 M	1000 (1600)	Inspect; clean external surfaces
<b>XU</b>	Cooling Hoses	50 H	6 M	1000 (1600)	Inspect for leaks
<b>XU</b>	Oil lines and fasteners	100 H	6 M	1000 (1600)	Inspect for leaks and loose fittings
<b>XU</b>	Engine oil change	100 H	6 M	1000 (1600)	Change the oil and filter
<b>XU</b>	Demand drive fluid (normal use)	100 H	12 M	1000 (1600)	Change fluid
<b>XU</b>	Rear gearcase oil	100 H	12 M	1000 (1600)	Change fluid
<b>XU</b>	Transmission oil	100 H	12 M	1000 (1600)	Change fluid

# MAINTENANCE

ITEM		MAINTENANCE INTERVAL (WHICHEVER COMES FIRST)			REMARKS
		HOURS	CALENDAR	MILES (KM)	
D	Fuel System	100 H	12 M	1000 (1600)	Cycle key to pressurize fuel pump; check for leaks at fill cap, fuel lines/rail and fuel pump.
XU	Engine Mounts	100 H	12 M	1000 (1600)	Inspect
	Exhaust Pipe / Silencer	100 H	12 M	1000 (1600)	Inspect
XU	Spark Plug	100 H	12 M	1000 (1600)	Inspect; replace as needed
XU	Wiring	100 H	12 M	1000 (1600)	Inspect for wear, routing, security; apply dielectric grease to connectors subjected to water, mud, etc.
D	Clutches (Drive/ Driven)	100 H	12 M	1000 (1600)	Inspect; clean; replace worn parts
D	Wheel Bearings	100 H	12 M	1000 (1600)	Inspect; replace as needed
D	Brake Fluid	200 H	24 M	2000 (3200)	Change every two years
	Spark Arrestor	300 H	36 M	3000 (4800)	Clean out; or remove clean out plug
XU	Coolant	-	60 M	-	Replace coolant (50/50 Extended Life Coolant)
XU	Valve Clearance	200 H	-	2000 (3200)	Inspect; adjust as needed
D	Toe Adjustment	-			Inspect periodically; adjust as needed
	Headlight Aim	-			Adjust as needed

## LUBRICATION GUIDE

Check and lubricate all components at the intervals outlined in the Periodic Maintenance Chart. Items not listed in the chart should be lubricated at the General Lubrication interval.

The a-arms and lower control arms are lubricated at the factory, and no additional lubrication will be needed. However, if these components are subjected to severe use, grease zerks have been provided for additional lubrication at the user's discretion.

ITEM	LUBE	CAPACITY AT FLUID CHANGE	INSPECTION PROCEDURE
Engine Oil (450/570)	PS-4 5W-50 4-Cycle Oil	2 qt. (1.9 l)	Maintain level in safe range on dipstick.
Brake Fluid	DOT 4 Brake Fluid	-	Maintain level between fill lines.
Transmission Oil	AGL Gearcase Lubricant & Transmission Fluid	32 oz. (948 ml)	Maintain level at bottom of fill hole threads.
Demand Drive (Front Gearcase)	Demand Drive	9 oz. (265 ml)	Maintain level at bottom of fill hole threads.
Front Prop Shaft	U-Joint Grease	-	Grease fittings (3 pumps maximum) every 500 miles, before long periods of storage, or after pressure washing or submerging.

## ENGINE OIL

Always check and change the oil at the intervals outlined in the Periodic Maintenance Chart. Always use the recommended engine oil. Always change the oil filter whenever changing oil.

Pay special attention to the oil level. A rise in oil level during cold weather can indicate contaminants collecting in the oil sump or crankcase. Change oil immediately if the oil level begins to rise. Monitor the oil level, and if it continues to rise, discontinue use and determine the cause. Your dealer can assist.

### **WARNING**

Vehicle operation with insufficient, deteriorated, or contaminated engine oil will cause accelerated wear and may result in engine seizure, accident and injury. Always perform the maintenance procedures as outlined in the Periodic Maintenance Chart.

## MAINTENANCE

### OIL RECOMMENDATIONS

Always change the oil filter whenever changing oil.

POLARIS recommends the use of POLARIS PS-4 Full Synthetic 5W-50 4-cycle oil or a similar oil for this engine. Oil may need to be changed more frequently if POLARIS oil is not used. Always use 5W-50 oil. Follow the manufacturer's recommendations for ambient temperature operation.

See the Lubrication Guide section for fluid recommendations, capacities and plug torques.

#### NOTICE

Mixing brands or using a non-recommended oil may cause serious engine damage. Always use the recommended oil. Never substitute or mix oil brands.

### OIL LEVEL

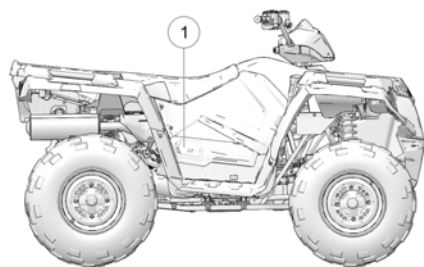

#### NOTE

Check the oil level when the engine is cold. Never check the oil with the engine running.

1. Position the vehicle on a level surface.
2. Access the oil dipstick and fill tube from the right side of the ATV ①. Remove the dipstick. Wipe it dry with a clean cloth.
3. Reinstall and tighten the dipstick.
4. Remove the dipstick and check the oil level
5. Add the recommended fluid as needed. Maintain the oil level in the safe range between the FULL and ADD marks. Do not overfill.
6. Reinstall and tighten the dipstick.

## OIL CHANGE

### IMPORTANT

Always change the oil filter whenever changing oil.

See the fluid recommendation table for capacities and plug torques. Always change the oil at the intervals outlined in the Periodic Maintenance Chart beginning on page 104. Always change the oil filter whenever changing oil.

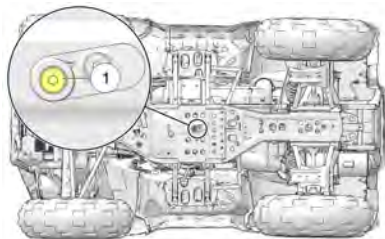

1. Position the vehicle on a level surface.
2. Start the engine. Allow it to warm up at idle for two to three minutes.
3. Stop the engine.
4. Clean the area around the drain plug ①.
5. Place a drain pan under the crankcase.
6. Remove the drain plug ①. Allow the oil to drain completely.

### CAUTION

Hot oil can cause burns to skin. Do not allow hot oil to contact skin.

7. Install a new sealing washer on the drain plug. The sealing surfaces on drain plug and crankcase should be clean and free of burrs, nicks or scratches.
8. Reinstall the drain plug. Torque to specification.

### TORQUE

11 +/- 1 ft-lbs (16 +/- 1.5 Nm)

# MAINTENANCE

---

## OIL FILTER CHANGE

### IMPORTANT

Always change the oil filter whenever changing oil.

See the fluid recommendation table for capacities and plug torques. Always change the filter at the intervals outlined in the Periodic Maintenance Chart beginning on page 104.

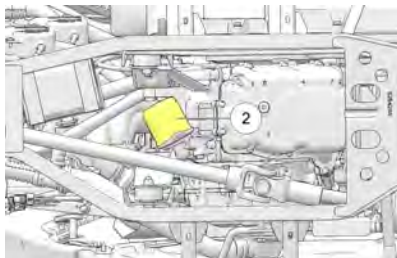

1. Place shop towels beneath the oil filter ②. Using an oil filter wrench (available from your POLARIS dealer), turn the filter counter-clockwise to remove it.
2. Using a clean dry cloth, clean the filter sealing surface on the crankcase.
3. Lubricate the o-ring on the new filter with a film of fresh engine oil. Check to make sure the o-ring is in good condition.
4. Install the new filter and rotate it clockwise by hand until the filter gasket contacts the sealing surface, then turn it an additional 3/4 turn.
5. Remove the dipstick.
6. Add the proper amount of the recommended oil. Do not overfill.
7. Reinstall the dipstick.
8. Place the transmission in PARK.
9. Lock the parking brake.
10. Start the engine. Allow it to idle for one to two minutes.
11. Stop the engine.
12. Check for leaks.
13. Check the oil level. Add oil as needed to bring the level to the upper mark on the dipstick.
14. Dispose of used filter and oil properly.



## TRANSMISSION OIL

### TORQUE

**Fill Plug:** 20–25 ft lbs. (27–34 Nm)

Always check and change the transmission oil at the intervals outlined in the Periodic Maintenance Chart. See the Fluid Recommendation table for capacities and plug torques. Maintain the oil level at the bottom of the fill plug hole. The fill plug is located on the right side of the ATV behind the footwell. The drain plug is located on the bottom rear side of the gearcase.

### OIL CHECK

1. Remove the fill plug ①. Check the oil level.
2. Add the recommended fluid as needed to bring the level to the bottom of the fill hole threads.
3. Reinstall the fill plug. Torque to specification.
4. Reinstall the footwell.

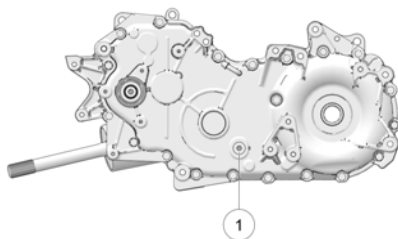

### OIL CHANGE

### TORQUE

**Drain Plug:** 20–25 ft lbs. (27–34 Nm)

1. Place a drain pan under the gearcase. Remove the drain plug ②. Allow the oil to drain completely.
2. Clean and reinstall the drain plug. Torque to specification.
3. Remove the fill plug. Add the proper amount of the recommended oil.
4. Reinstall the fill plug. Torque to specification.
5. Check for leaks.
6. Reinstall the footwell.
7. Dispose of used oil properly.

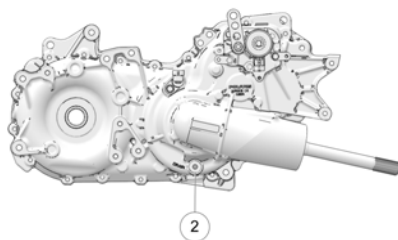

## MAINTENANCE

### FRONT GEARCASE (DEMAND DRIVE) FLUID

Always check and change the demand drive fluid at the intervals outlined in the Periodic Maintenance Chart.

Change the front gearcase fluid every 25 hours if the ADC unit is exposed to extreme use. Extreme use includes any of the following:

- operation in ADC mode for prolonged periods
- constant ADC operation on hilly or mountainous terrain
- ADC is the primary mode of all-wheel-drive operation

#### TIP

If the front gearcase makes excessive noise during ADC operation, change the demand drive fluid. If the noise continues, please see your POLARIS dealer or other qualified service facility for service.

Use the recommended fluid. Use of other fluids may result in improper operation of components. Maintain the fluid level at the bottom of the fill hole threads. The fill plug is located on the right side of the demand drive unit. The drain plug is located on the bottom right side of the unit.

### FLUID CHECK

#### TORQUE

**Fill Plug: 8–10 ft lbs (11–14 Nm)**

1. Position the vehicle on a level surface. Remove the fill plug ①. Check the fluid level.
2. Add the recommended fluid as needed to bring the level to the bottom of the fill hole threads.
3. Reinstall the fill plug. Torque to specification.

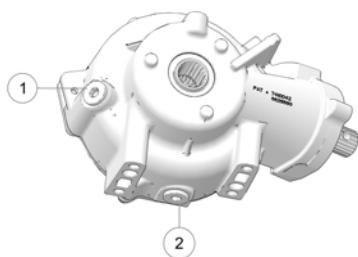

---

## FLUID CHANGE

### TORQUE

**Drain Plug: 11 ft lbs (15 Nm)**

1. Position the vehicle on a level surface. Remove the fill plug.
2. Place a drain pan under the demand drive unit. Remove the drain plug ②. Allow the fluid to drain completely.
3. Clean and reinstall the drain plug. Torque to specification.
4. Add the proper amount of the recommended fluid.
5. Reinstall the fill plug. Torque to specification.
6. Check for leaks. Dispose of used fluid properly.

## POWER STEERING UNIT

If your model is equipped with power steering, frequently clean the areas around and on the power steering unit to allow proper cooling. Clean these areas thoroughly.

## STEERING ASSEMBLY

The steering assembly of the ATV should be checked periodically for loose nuts and bolts. If loose nuts and bolts are found, see your authorized dealer or other qualified service facility before operating the vehicle.

## COOLING SYSTEM

The engine coolant level is controlled, or maintained, by the recovery system. The recovery system components are the recovery bottle, the radiator filler neck, the radiator pressure cap and the connecting hose.

As coolant operating temperature increases, the expanding (heated) excess coolant is forced out of the engine, past the pressure cap, and into the recovery bottle. As engine coolant temperature decreases the contracting (cooled) coolant is drawn back up from the bottle, past the pressure cap, and into the radiator.

Some coolant level drop on new vehicles is normal as the system is purging itself of trapped air. Check the coolant level and maintain as recommended by adding coolant to the recovery bottle.

POLARIS recommends the use of POLARIS Antifreeze 50/50 Premix. This antifreeze is already premixed and ready to use. Do not dilute with water. See the Polaris Products section for the part numbers.

## MAINTENANCE

---

### RECOVERY BOTTLE COOLANT

The recovery bottle fluid level can be accessed from the front left wheel well.

1. View the fluid level in the bottle.
2. If the level is low, remove the bottle cap and add coolant as needed. Maintain the coolant level between the minimum and maximum marks on the bottle (when the fluid is cool).
3. Reinstall the cap.
4. Close and secure the front box and cover.

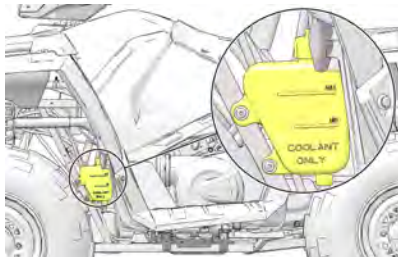

### RADIATOR COOLANT

To ensure that the coolant maintains its ability to protect the engine, we recommend that the system be completely drained every five (5) years and fresh Antifreeze 50/50 Premix added.

Any time the cooling system has been drained for maintenance or repair, replace the coolant with fresh Antifreeze 50/50 Premix. If the recovery bottle has run dry, check the level in the radiator. Add coolant as needed.

#### CAUTION

Escaping steam can cause burns. Never remove the pressure cap while the engine is warm or hot. Always allow the engine to cool before removing the pressure cap.

1. Access the pressure cap under the front box. See the Front Compartment section for details.
2. Remove the pressure cap.
3. Using a funnel, slowly add coolant through the radiator filler neck.
4. Reinstall the pressure cap. Use of a non-standard pressure cap will not allow the recovery system to function properly. Your POLARIS dealer can provide the correct replacement part.
5. Close and secure the front box and cover.

## BRAKES

### HAND BRAKE

The front and rear brakes are hydraulic disc brakes, activated by moving the single brake lever toward the handlebar. These brakes are self-adjusting.

Under normal operation, the diaphragm extends into the reservoir as fluid level drops. If the fluid level is low and the diaphragm is not extended, a leak is likely and the diaphragm should be replaced. To ensure proper diaphragm operation, always fill the reservoir as needed whenever the cover is loosened or removed. Do not overfill.

#### WARNING

An over-full master cylinder may cause brake drag or brake lock-up, which could result in serious injury or death. Maintain brake fluid at the recommended level. Do not overfill.

The following checks are recommended to keep the brake system in good operating condition. Check more often if brakes are used heavily under normal operation.

1. Always keep brake fluid at an adequate level. See the Master Cylinder/Brake Fluid section for details.
2. Check the brake system for fluid leaks.
3. Check the brakes for excessive travel or spongy feel.
4. Check the friction pads for wear, damage and looseness. Replace brake pads when they are worn to .030" (0.762 mm).
5. Check the security and surface condition of the disc. Clean any grease using a recommended brake cleaner or alcohol. Do not use spray lubricants or other petroleum-based products. If you discover any damage (cracks, excessive corrosion, warping) see your dealer for service before operating.

### AUXILIARY FOOT BRAKE

The hydraulic auxiliary brake system requires no adjustment. Check the brake fluid level frequently for the auxiliary brake system.

### **SEAT REMOVAL (TOURING/1-UP MODELS)**

1. Locate the seat removal latch in the center of the seat's rear.
2. Pull on the latch handle to disengage the seat from the vehicle's frame.
3. Remove the seat.

### **SEAT REMOVAL (X2)**

1. Remove any cargo from the cargo box before removing the seat.
2. Stand beside the vehicle. Pull the cargo box release lever upward. Lift the front of the cargo box.
3. Grasp edge of the seat near the opposite rear corner.
4. Pull upward abruptly to disengage the under-seat fasteners.
5. Remove the seat.

### **SIDE PANEL REMOVAL**

To remove the side panel, do the following:

1. Remove the seat.
2. Use a flat screwdriver to remove the plastic rivets securing the side panel.
3. Grasp the rear of the side panel near the rear cab. With a firm motion, pull the side panel outward to disengage the side panel from the grommets.
4. Pull the panel outward and rearward to remove it.

### **FOOTWELL REMOVAL (1-UP MODELS)**

To remove the footwell, do the following:

1. Remove the four screws on the bottom of the footwell.
2. Use a flat screwdriver to remove the plastic rivets securing the footwell to the fenders.
3. Remove the footwell.

## FOOTWELL/FOOTWELL SUPPORT REMOVAL (2-UP MODELS)

To remove the footwell, do the following:

1. Remove the six screws on the bottom of the footwell.
2. Use a flat screwdriver to remove the plastic rivets securing the footwell to the fenders.
3. Remove the footwell.
4. If removing the footwell support is necessary to access the clutch cover, remove the hex flange screw securing the support to the frame.

## TIRES

### WARNING

Operating your ATV with worn tires, improperly inflated tires, non-standard tires or improperly installed tires will affect vehicle handling and could cause an accident resulting in serious injury or death. Always follow all tire maintenance procedures as outlined in this manual and on the labels on the vehicle. Always use original equipment size and type when replacing tires.

Refer to the specifications section for recommended tire type, size and pressure.

### TIRE TREAD DEPTH

Always replace tires when tread depth is worn to 1/8" (3 mm) or less.

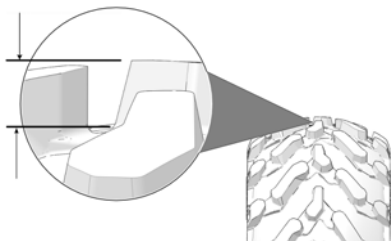

### FRONT WHEEL HUB TIGHTENING

Front wheel bearing tightness and spindle nut retention are critical component operations. All service must be performed by your authorized dealer or other qualified service facility.

## MAINTENANCE

---

### WHEEL REMOVAL

1. Stop the engine.
2. Place the transmission in PARK.
3. Lock the parking brake.
4. Loosen the wheel nuts slightly.

#### **WARNING**

Do not service axle nuts that have a cotter pin installed. Your authorized dealer can assist.

5. Elevate the side of the vehicle by placing a suitable stand under the foot rest frame.
6. Remove the wheel nuts.
7. Remove the wheel.

### WHEEL INSTALLATION

1. Place the transmission in PARK.
2. Lock the parking brake.
3. Place the wheel on the hub with the valve stem toward the outside and rotation arrows on the tire pointing toward forward rotation (if equipped).
4. Install the wheel nuts and finger-tighten them.
5. Lower the vehicle to the ground.
6. Torque the wheel nuts to specification.



#### **WARNING**

Loose nuts could cause a tire to come off during operation, which could result in an accident or overturn. Always ensure that all nuts are torqued to specification.



## WHEEL NUT TORQUE SPECIFICATIONS

Check the wheel nut torques occasionally and when they've been loosened for maintenance service.

<p>Lug Nut (Aluminum Wheels)</p> 	<p>Front and Rear</p>	<p>30 ft. lbs. (41 Nm) PLUS 1/4 TURN or 70 degrees</p>
<p>2-Piece Flange Nut (Steel Wheels)</p> 	<p>Front and Rear</p>	<p>27 ft. lbs. (37 Nm)</p>

### TOE ALIGNMENT

#### WARNING

Severe injury or death can result from improper toe alignment and adjustment. Do not attempt to adjust tie rod alignment. All tie rod adjustments should be performed by an authorized POLARIS dealer or other qualified service facility.

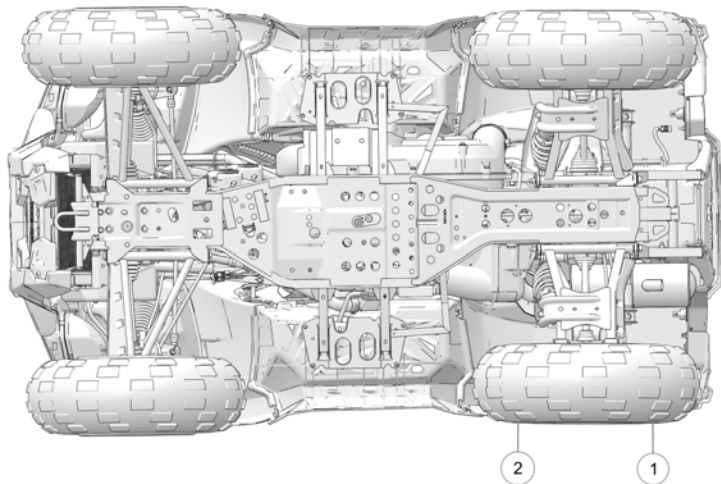

Use the following procedure to check the toe alignment of the vehicle. The recommended toe alignment is 1/4–1/2 inch (6–12 mm).

1. Position the vehicle on a level surface.
2. Place the handlebars in a straight-ahead position.
3. Tie a length of string between two stands. Position the stands so that the string is flush with the side of the rear tire. If available, you may use a long straight-edge instead of string.
4. Measure the distance from the string to the rim at the front ① and rear ② of the front rim. The rear measurement should be 1/8–1/4 inch (3–6 mm) more than the front measurement on each side of the vehicle to obtain the recommended 1/4–1/2 inch (6–12 mm) toe out alignment.
5. Repeat the measurement procedure on the other side of the vehicle.
6. If you discover improper alignment, see your POLARIS dealer for service.

## AIR FILTER

1. Remove the seat. Remove the air box cover clips. Remove the air box cover ①.
2. Remove the filter.
3. Remove the fabric type pre- filter from the main filter. Wash the pre- filter in soapy water, then rinse and let dry.
4. Reinstall the pre-filter over the main filter. Install a new main filter if needed.
5. Reinstall the filter into the air box.
6. Reinstall the air box cover and the seat.

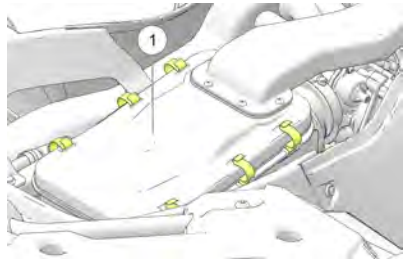

## FUSE REPLACEMENT

If the engine stops or will not start, or if you experience other electrical failures, a fuse may need replacement. Locate and correct any short circuits that may have caused the blown fuse, then replace the fuse. Spare fuses are provided in the fuse box.

1. Open the front box cover, and remove the access panel.
2. Remove fuse box cover.
3. Remove the suspect fuse from the fuse panel. If the fuse is blown, install a new fuse with the same amperage.
4. Secure the fuse box cover and access panel.
5. Secure the front box cover.

### LIGHTS

#### CAUTION

Poor lighting can result in reduced visibility when driving. Headlight and taillight lenses become dirty during normal operation. Clean headlights frequently and replace burned out headlamps promptly.

Always make sure lights are adjusted properly for best visibility.

### HEADLIGHT LAMP REPLACEMENT

When servicing a halogen lamp, don't touch the lamp with bare fingers. Oil from your skin leaves a residue, causing a hot spot that will shorten the life of the lamp. If fingers do touch a lamp, clean it with denatured alcohol.

#### CAUTION

Hot components can cause burns to skin. Allow lamps to cool before servicing.

1. Remove the seven (7) headlight pod screws. Pull the pod cover forward.
2. Unplug the headlamp from the wiring harness. Be sure to pull on the connector, not on the wiring.
3. Turn the lamp counter-clockwise to remove it.
4. Apply dielectric grease to the socket and install the new lamp. Make sure the tab on the lamp locates properly in the housing.
5. Reassemble the pod.

## HIGH BEAM ADJUSTMENT

The headlight beam can be adjusted slightly upward or downward. Use the following procedure to make the adjustment.

### NOTE

Image below is for reference only. Your model may differ slightly.

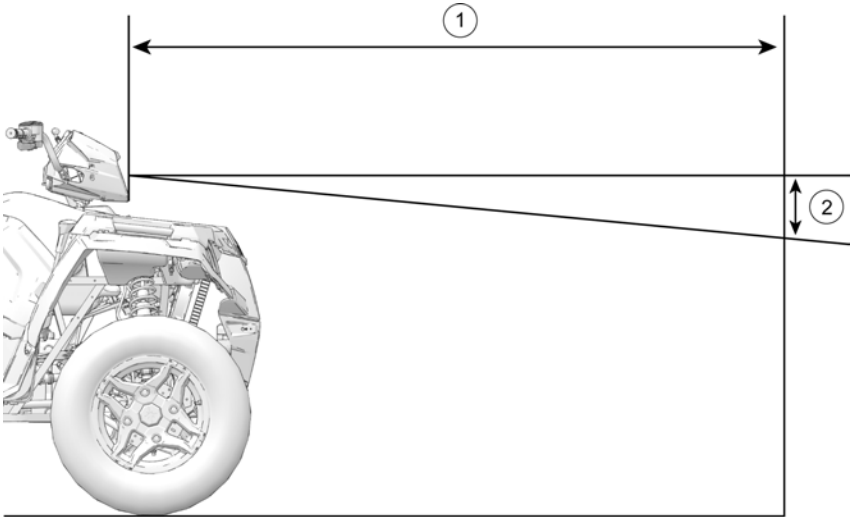

1. Position the vehicle on a level surface with the headlight approximately 25 ft. (7.6 m) from a wall ①. Place the transmission in PARK.
2. Measure the distance from the floor to the center of the headlight and make a mark on the wall at the same height.
3. Start the engine. Turn the headlight switch to high beam.
4. Observe the headlight aim on the wall. The most intense part of the headlight beam should be 2 in. (5 cm) below the mark on the wall ②. Include rider weight on the seat when measuring.
5. The adjustment screw is located on the right side of the headlight pod. To adjust the beam, loosen the screw. Adjust the headlamp to the desired position, then tighten the screw.

## MAINTENANCE

---

### LOW BEAM ADJUSTMENT

The low beam can be adjusted slightly upward or downward.

1. Loosen the Phillips screw located at the rear of the headlamp.
2. Tilt the headlamp upward or downward.
3. Tighten the screw.

### HEADLIGHT HOUSING REPLACEMENT

To replace the headlight housing, do the following:

1. Remove the seven (7) headlight pod screws.
2. Pull the pod cover forward.
3. Unplug the headlamp from the wiring harness.
4. Use a small screwdriver to remove the o-rings from the headlight mounting tabs.
5. Pull the headlight housing up from bracket for removal.
6. Reverse the steps to install the new housing and reassemble the pod.

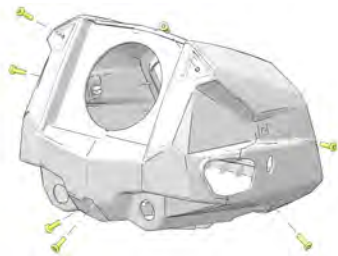

### LOWER HEADLAMP REPLACEMENT

1. Turn the back of the headlight harness counter-clockwise and pull the harness assembly away from the headlight assembly.
2. Remove the headlamp and install the new headlamp.
3. Reinstall the harness assembly into the headlight assembly.

#### NOTE

Take care to avoid touching the glass on the new headlight bulb. Fingerprints on the glass may result in premature failure.

4. Turn the headlight harness clockwise to secure the headlamp.

## TAILLIGHTS/BRAKE LIGHTS REPLACEMENT

Procedure to replace taillights:

### **ALL MODELS EXCEPT X2:**

1. Remove the harness connector from the back of the light assembly.
2. Turn the lamp counter-clockwise to remove it.
3. Apply dielectric grease to the socket and install the new lamp.
4. Reinstall the harness connector.
5. Test the light for proper operation.

### **X2:**

1. Open the tailgate.
2. Remove the two screws near the tailgate latch.
3. Grasp the entire taillight assembly and pull it away from the vehicle.
4. Remove the harness connector from the back of the light assembly.
5. Turn the lamp counter-clockwise to remove it.
6. Apply dielectric grease to the socket and install the new lamp.
7. Reinstall the harness connector.
8. Test the light for proper operation.
9. Reinstall the taillight assembly.
10. Reinstall the two screws.

### SPARK PLUGS

#### SPARK PLUG RECOMMENDATIONS

Refer to the specifications section for the recommended spark plug type and gap for your vehicle. Torque spark plugs to specification.

#### NOTICE

Using non-recommended spark plugs can result in serious engine damage. Always use POLARIS-recommended spark plugs or their equivalent.

ENGINE	TORQUE SPECIFICATION
450	15 ft-lbs (20 Nm)
570	9 ft-lbs (12 Nm)

#### SPARK PLUG INSPECTION

Spark plug condition is indicative of engine operation. Check the spark plug firing end condition after the engine has been warmed up and the vehicle has been driven at higher speeds. Immediately check the spark plug for correct color.

#### CAUTION

A hot exhaust system and engine can cause burns. Wear protective gloves when removing a spark plug for inspection.

1. Rotate the spark plug cap 1/4 turn and pull it off the spark plug.
2. Rotate the spark plug counter-clockwise to remove it.
3. Reverse the procedure for spark plug installation. Torque to specification.

#### NORMAL PLUG

The normal insulator tip is gray, tan or light brown. There will be few combustion deposits. The electrodes are not burned or eroded. This indicates the proper type and heat range for the engine and the service.

The tip should not be white. A white insulator tip indicates overheating, caused by use of an improper spark plug or incorrect throttle body adjustments.

#### WET FOULED PLUG

The wet fouled insulator tip is black. A damp oil film covers the firing end. There may be a carbon layer over the entire nose. Generally, the electrodes are not worn. General causes of fouling are excessive oil, use of non-recommended oil or poor fuel quality.



## VEHICLE IMMERSION

If your vehicle becomes immersed, major engine damage can result if the machine is not thoroughly inspected. Take the vehicle in for service before starting the engine. Your POLARIS dealer can provide this service.

If it's impossible to take your ATV to a dealer before starting it, follow the steps outlined below.

1. Move the ATV to dry land or at the very least, to water below the footrests.
2. Check the air box. If water is present, dry the air box and replace the filter with a new filter. If equipped, remove the air box drain plug to drain water. Reinstall the drain plug.

### CAUTION

Serious damage could occur if the air box drain plug is not reinstalled properly.

3. Remove the spark plugs.
4. Turn the engine over several times using the electric start.
5. Dry the spark plugs. Reinstall the plugs or install new plugs.
6. Attempt to start the engine. If necessary, repeat the drying procedure.

### CAUTION

Serious damage can occur after immersion if fluids are not changed promptly.  
Your authorized dealer can assist.

7. Take the vehicle in for service as soon as possible, whether you succeed in starting it or not. Your authorized dealer can provide the required service.
8. If water has been ingested into the PVT, follow the procedure in the PVT System section for drying out the PVT.

### SPARK ARRESTER

#### WARNING

Do not perform clean out immediately after the engine has been run, as the exhaust system becomes very hot. Serious burns could result from contact with exhaust components.

To reduce fire hazard, make sure that there are no combustibile materials in the area when purging the spark arrester.

Wear eye protection.

Do not stand behind or in front of the vehicle while purging the carbon from the spark arrester.

Never run the engine in an enclosed area. Exhaust contains poisonous carbon monoxide gas.

Do not go under the machine while it is inclined. Set the hand brake and block the wheels to prevent roll back.

Failure to heed these warnings could result in serious personal injury or death.

The exhaust pipe must be periodically purged of accumulated carbon as follows:

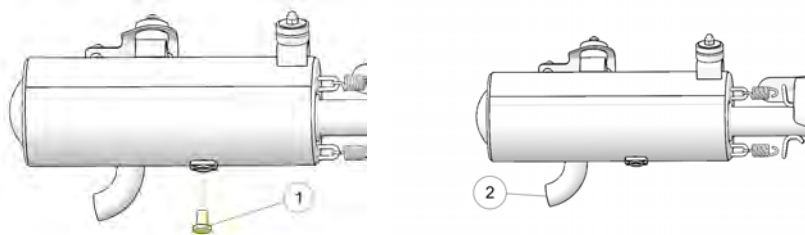

1. Remove the clean out plugs ① located on the bottom of the muffler.
2. Place the transmission in Park and start the engine. Purge accumulated carbon from the system by momentarily revving the engine several times.
3. If some carbon is expelled, cover the exhaust outlet ② and lightly tap on the pipe around the clean out plugs with a rubber mallet while revving the engine several more times.
4. If particles are still suspected to be in the muffler, back the machine onto an incline so the rear of the machine is one foot higher than the front. Set the hand brake and block the wheels. Make sure the machine is in Park and repeat Steps 2 and 3. **SEE WARNING**

5. If particles are still suspected to be in the muffler, drive the machine onto the incline so the front of the machine is **one foot higher** than the rear. Set the hand brake and block the wheels. Make sure the machine is in Park and repeat Steps 2 and 3. **SEE WARNING**
6. Repeat steps 2 through 5 until no more particles are expelled when the engine is revved.
7. Stop the engine and allow the arrestor to cool.
8. Reinstall the clean out plugs.

## PVT SYSTEM

### **WARNING**

Failure to comply with the instructions in this warning can result in severe injury or death.

Do not modify any component of the PVT system. Doing so may reduce its strength so that a failure may occur at a high speed. The PVT system has been precision balanced. Any modification will cause the system to be out of balance, creating vibration and additional loads on components.

The PVT system rotates at high speeds, creating large amounts of force on clutch components. Extensive engineering and testing has been conducted to ensure the safety of this product. However, as the owner, you have the following responsibilities to make sure this system remains safe:

- Always follow all recommended maintenance procedures. Always look for and remove debris inside and around the clutch and vent system when replacing the belt.
- See your POLARIS dealer, or other qualified person, for service and repair assistance.
- This PVT system is intended for use on POLARIS products only. Do not install it in any other product.
- Always make sure the PVT housing is securely in place during operation.

The basic operation of the POLARIS PVT system is dependent on engine speed and vehicle torque requirements. As engine speed increases, the force exerted on the movable drive sheave by the flyweights also increases. This, in turn, increases the amount of pinch applied to the drive belt. Similarly, if the engine speed decreases, the amount of centrifugal force decreases, reducing the amount of belt pinch.

On POLARIS ATVs, the approximate gear ratio difference between high and low range is 1:2.25. This difference in gearing affects the operation of the PVT, especially at speeds less than 7 MPH (11 km/h), due to the system's dependence on engine speed.

## MAINTENANCE

---

For example, when operating at a ground speed of 3 MPH (5 km/h) in low range, the engine speed would be around 3000 RPM. This is well above the engagement speed of 1600 - 1800 RPM. However, in high range at 3 MPH (5 km/h), the engine would be running at only 1500 RPM. Whenever operating this close to the engagement speed, the engine may be running at a speed too low to provide the pinch needed to prevent belt slip. Belt slip is responsible for creating the excessive heat that destroys belts, wears clutch components and causes outer clutch covers to fail.

The air temperature in the clutch cover is substantially reduced by using low range while operating at low ground speeds. Reducing the temperature inside the clutch cover greatly extends the life of the PVT components (belt, cover, etc.).

### WHEN TO USE LOW RANGE AND HIGH RANGE

CONDITION	RANGE TO USE
Operating at speeds less than 7 MPH (11 km/h)	Low
Towing heavy loads	Low
Operating in rough terrain (swamps, mountains, etc.)	Low
Operating at speeds greater than 7 MPH (11 km/h)	High

### PVT DRYING

There may be some instances when water is accidentally ingested into the PVT system. Use the following instructions to dry it out before operating.

1. Position the vehicle on a level surface.
2. Remove the drain plug. Allow the water to drain completely. Reinstall the drain plug.
3. Start the engine. Place the transmission in PARK.
4. Apply varying throttle for 10-15 seconds to expel the moisture and air-dry the belt and clutches. Do not hold the throttle wide open for more than 5 seconds.
5. Allow the engine RPM to settle to idle speed, then shift the transmission to low range.
6. Test for belt slippage. If the belt slips, repeat the process. Your vehicle requires service as soon as possible, which your authorized dealer can provide.

### **PVT DRYING**

There may be some instances when water is accidentally ingested into the PVT system. Use the following instructions to dry it out before operating.

1. Position the vehicle on a level surface.
2. Remove the drain plug. Allow the water to drain completely. Reinstall the drain plug.
3. Start the engine. Place the transmission in PARK.
4. Apply varying throttle for 10-15 seconds to expel the moisture and air-dry the belt and clutches. Do not hold the throttle wide open for more than 5 seconds.
5. Allow the engine RPM to settle to idle speed, then shift the transmission to low range.
6. Test for belt slippage. If the belt slips, repeat the process. Your vehicle requires service as soon as possible, which your authorized dealer can provide.

### BATTERY

#### **⚠ WARNING**

Improperly connecting or disconnecting battery cables can result in an explosion and cause serious injury or death. When removing the battery, always disconnect the negative (black) cable first. When reinstalling the battery, always connect the negative (black) cable last.

Your ATV is equipped with a sealed battery, which requires little maintenance. POLARIS does not recommend using a conventional battery in this vehicle. The orientation of the battery could result in electrolyte leakage, which would shorten the life of the battery considerably.

Always keep battery terminals and connections free of corrosion. If cleaning is necessary, remove corrosion with a stiff wire brush. Wash with a solution of one tablespoon baking soda and one cup water. Rinse well with tap water and dry off with clean shop towels. Coat the terminals with dielectric grease or petroleum jelly.

### BATTERY REMOVAL

#### **NOTICE**

If electrolyte spills, immediately wash it off with a solution of one tablespoon baking soda and one cup water to prevent damage to the vehicle.

1. Disconnect the battery hold-down strap.
2. Remove the battery cover (if equipped).
3. On conventional batteries, remove the battery vent tube.
4. Disconnect the black (negative) battery cable first.
5. Disconnect the red (positive) battery cable last.
6. Lift the battery out of the ATV. Be careful not to tip a conventional battery sideways, which could spill electrolyte.

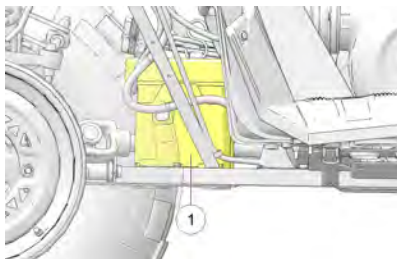

## BATTERY INSTALLATION

### NOTICE

Using a new battery that has not been fully charged can damage the battery and result in a shorter life. It can also hinder vehicle performance. Follow the battery charging procedure in Chapter 10 “Electrical” before installing the battery.

### CAUTION

To reduce the chance of sparks: Whenever removing the battery, disconnect the black (negative) cable first. When reinstalling the battery, install the black (negative) cable last.

### NOTICE

Batteries on SP models are mounted outside the frame in a similar location. All removal and installation steps are the same.

1. Clean battery cables and terminals with a stiff wire brush. Corrosion can be removed using a solution of one cup water and one tablespoon baking soda. Rinse well with clean water and dry thoroughly.
2. Place the Battery in the tray.
3. Coat terminals and bolt threads with Nyogel® Grease.

Nyogel® Grease  
(PN 2871329)

4. Connect and tighten the red (positive) cable ⑤. Torque to specification.

### TORQUE

Battery Terminals:  
**5 ft-lbs (7 Nm)**

# MAINTENANCE

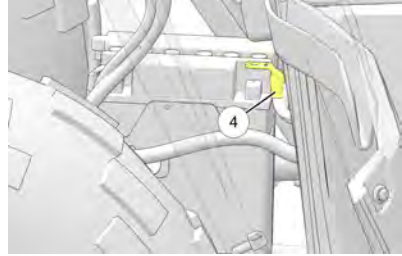
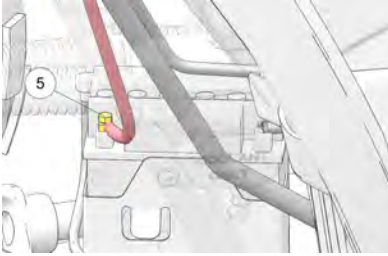

5. Connect and tighten the black (negative) cable ④. Torque to specification.

## TORQUE

Battery Terminals:  
**5 ft-lbs (7 Nm)**

6. Install clear battery vent tube from vehicle to battery vent. (Applies to Conventional Batteries Only).

## ⚠ WARNING

Vent tube must be free from obstructions and kinks and securely installed. If not, battery gases could accumulate and cause an explosion. The vent tube should be routed away from frame and body to prevent contact with Route the cables correctly.

7. Install the battery cover ③.

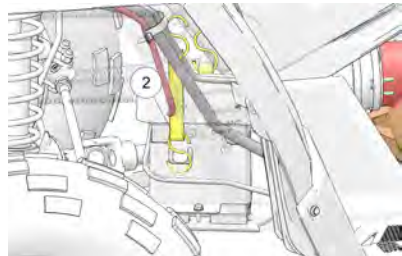
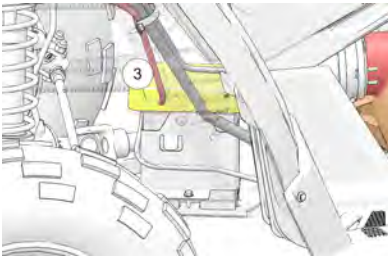

8. Install the battery strap ②.
9. Verify that cables are properly routed.



## BATTERY STORAGE

Whenever the vehicle is not used for a period of three months or more, remove the battery from the vehicle, ensure that it's fully charged, and store it out of the sun in a cool, dry place. Check battery voltage each month during storage and recharge as needed to maintain a full charge.

POLARIS recommends maintaining battery charge by using a POLARIS Battery Tender charger or by charging about once a month to make up for normal self-discharge. Battery Tender can be left connected during the storage period, and will automatically charge the battery if the voltage drops below a pre-determined point. See the Polaris Products section for the part numbers.

## BATTERY CHARGING

The following battery charging instructions apply only to the installation of a sealed battery. Read all instructions before proceeding with the installation of this battery.

The sealed battery is already filled with electrolyte and has been sealed and *fully charged* at the factory. *Never* pry the sealing strip off or add any other fluid to this battery.

The single most important thing about maintaining a sealed battery is to keep it fully charged. Since the battery is sealed and the sealing strip cannot be removed, you must use a voltmeter or multimeter to measure DC voltage.

### WARNING

An overheated battery may explode, causing severe injury or death. Always watch charging times carefully. Stop charging if the battery becomes very warm to the touch. Allow it to cool before resuming charging.

For a refresh charge, follow all instructions carefully.

1. The battery should be disconnected from a load or charger for at least two hours before checking voltage. Check the battery voltage with a voltmeter or multimeter. A fully charged battery will register 12.8 V or higher.
2. If the voltage is less than 12.8 volts, recharge the battery at 1.2 amps or less until battery voltage is 12.8 or greater.
3. When using an automatic charger, refer to the charger manufacturer's instructions for recharging. When using a constant current charger, use the following guidelines via the table below.

## BATTERY CHARGING (SEALED BATTERY)

Always verify battery condition before and 1-2 hours after the end of charging.

## MAINTENANCE

STATE OF CHARGE	VOLTAGE	ACTION	CHARGE TIME (USING CONSTANT CURRENT CHARGER @ STANDARD AMPS SPECIFIED ON TOP OF BATTERY)
100%	12.8-13.0 volts	None, check at 3 mos. from date of manufacture	None required
75%-100%	12.5-12.8 volts	May need slight charge, if no charge given, check in 3 months	3-6 hours
50%-75%	12.0-12.5 volts	Needs charge	5-11 hours
25%-50%	11.5-12.0 volts	Needs charge	At least 13 hours, verify state of charge
0%-25%	11.5 volts or less	Needs charge with desulfating charger	At least 20 hours

## CAMBER AND CASTER

The camber and caster are non-adjustable.

## REAR SPRING

The rear shock absorber spring is adjusted by rotating the adjuster either clockwise or counter-clockwise to increase or decrease spring tension.

Accessory springs are available through your POLARIS dealer.

## HANDLEBARS

The handlebars can be adjusted for rider preference.

### **WARNING**

Improper adjustment of the handlebars or incorrect torquing of the adjuster block tightening bolts can cause limited steering or loosening of the handlebars, resulting in loss of control and serious injury or death. Follow the adjustment procedures exactly, or see your POLARIS dealer for service.

1. Remove the headlight pod.
2. Loosen the four handlebar bolts.
3. Adjust the handlebar to the desired height. Be sure the handlebars do not contact the gas tank or any other part of the machine when turned fully to the left or right.

4. Torque the front two bolts to 10-12 ft-lbs (14-17 Nm), then torque the rear two bolts. A gap of up to 1/8" (3 mm) will remain at the rear of the clamp blocks.
5. Re-install the headlight pod.

## CLEANING AND STORAGE

### WASHING THE VEHICLE

If a high pressure water system is used for cleaning (not recommended), exercise extreme caution. The water may damage components and could remove paint and decals. Avoid directing the water stream at the following items:

- Wheel bearings
- Radiator
- Transmission seals
- Cab and body panels
- Electrical components
- Switches and controls
- Fuel system components
- Labels and decals

If an informational or graphic label becomes illegible or comes off, contact your POLARIS dealer to purchase a replacement. Replacement *safety* labels are provided by POLARIS at no charge.

Grease all zerk fittings immediately after washing. Allow the engine to run for a while to evaporate any water that may have entered the engine or exhaust system.

### WASHING TIPS

- Avoid the use of harsh cleaners, which can scratch the finish.
- Do not use a power washer to clean the vehicle.
- Do not use medium to heavy duty compounds on the finish.
- Always use clean cloths and pads for cleaning and polishing. Old or reused cloths and pads may contain dirt particles that will scratch the finish.

### POLISHING THE VEHICLE

POLARIS recommends the use of common household aerosol furniture polish for polishing the finish on your POLARIS vehicle. Follow the instructions on the container.

## MAINTENANCE

---

### POLISHING TIPS

- Avoid the use of automotive products, some of which can scratch the finish of your vehicle.
- Always use clean cloths and pads for cleaning and polishing. Old or reused cloths and pads may contain dirt particles that will scratch the finish.

### STORAGE TIPS

#### **NOTICE**

Starting the engine during the storage period will disturb the protective film created by fogging and damage could occur. Never start the engine during the storage period.

### CLEAN THE EXTERIOR

Make any necessary repairs and clean the vehicle as recommended. See the Washing the Vehicle section.

### STABILIZE THE FUEL

1. Fill the fuel tank.
2. Add POLARIS Carbon Clean Fuel Treatment or POLARIS Fuel Stabilizer or equivalent fuel treatments or stabilizers. Follow the instructions on the container for the recommended amount. Carbon Clean removes water from fuel systems, stabilizes fuel and removes carbon deposits from pistons, rings, valves and exhaust systems.
3. Allow the engine to run for 15-20 minutes to allow the stabilizer to disperse through the entire fuel delivery system.

### OIL AND FILTER

Change the oil and filter. See the Engine Oil section.

### AIR FILTER / AIR BOX

Replace the air filter. See Maintenance Chapter. Clean the air box.

### FLUID LEVELS

Inspect the fluid levels. Add or change fluids as recommended in the Periodic Maintenance Chart.

- Demand drive fluid (front gearcase)
- Rear gearcase fluid (if equipped)
- Transmission fluid
- Brake fluid (change every two years and any time the fluid looks dark or contaminated)
- Coolant (test strength/fill)

### INSPECT AND LUBRICATE

Inspect all cables and lubricate all areas of the vehicle as recommended in the Periodic Maintenance Chart.

### FOG THE ENGINE

1. Treat the fuel system with POLARIS Carbon Clean or other equivalent fuel treatment. Follow the instructions on the container. Start the engine. Allow it to idle for several minutes so the Carbon Clean reaches the injectors. Stop the engine.
2. Remove the spark plugs and add 2-3 tablespoons of engine oil. To access the plug holes, use a section of clear 1/4" hose and a small plastic squeeze bottle filled with the pre-measured amount of oil. *Do this carefully! If you miss the plug holes, oil will drain from the spark plug cavities into the hole at the front of the cylinder head, and appear to be an oil leak.*
3. Reinstall the spark plugs. Torque to specification.
4. Apply dielectric grease to the inside of each spark plug cap. *Do not reinstall the cap onto the plug at this step.*
5. Turn the engine over several times. Oil will be forced in and around the piston rings and ring lands, coating the cylinder with a protective film of fresh oil.
6. Reinstall the spark plug caps.
7. If POLARIS fuel system additive is not used, fuel tank, fuel lines, and injectors should be completely drained of gasoline.

### BATTERY MAINTENANCE

See the Battery Storage and Battery Charging sections for storage and charging procedures.

### STORAGE AREA / COVERS

Be sure the storage area is well ventilated. Cover the vehicle with a genuine POLARIS cover. Do not use plastic or coated materials. They do not allow enough ventilation to prevent condensation, and may promote corrosion and oxidation.

### **TRANSPORTING THE ATV**

Follow these procedures when transporting the vehicle.

1. Stop the engine.
2. Place the transmission in PARK.
3. Lock the parking brake.
4. Secure the fuel cap, oil cap and seats.
5. Always tie the frame of the ATV to the transporting unit securely with suitable straps or rope. Do not attach tie straps to the front A- arm bolt pockets, racks or handlebars.
6. Remove the key to prevent loss during transporting.

# SPECIFICATIONS

## SPORTSMAN 450 HO / HO EPS

SPORTSMAN 450 HO / HO EPS	
Maximum Weight Capacity	485 lbs. (220 kg) (operator, cargo, accessories)
Dry Weight	450 HO: 685 lbs. (311 kg) 450 HO EPS: 699 lbs. (317 kg)
Fuel Capacity	4.5 gal. (17 l)
Engine Oil Capacity	2 qts. (1.9 l)
Coolant Capacity	2.7 qts. (2.5 l)
Rear Gearcase Oil Capacity	7.1 oz. (210 ml)
Demand Drive Fluid Capacity	9 oz. (265 ml)
Transmission Oil Capacity	32 oz. (948 ml)
Front Rack/Storage Box Capacity	90 lbs. (40.8 kg)
Rear Rack Capacity	180 lbs. (81.6 kg)
Receiver Hitch Tongue Capacity	120 lbs. (54 kg) (Rear rack capacity and tongue weight not to exceed 180 lbs./81.6 kg)
Hitch Towing Rating	1225 lbs. (555.7 kg)
Unbraked Trailer Towing Capacity*	1786 lbs. (810 kg)
Overall Length	83 in. (211 cm)
Overall Width	48 in. (122 cm)
Overall Height	46 in. (117 cm)
Wheelbase	50.5 in. (128.3 cm)
Ground Clearance	10 in. (25.4 cm)
Minimum Turning Radius	65 in. (165 cm) unloaded
Engine	Single overhead cam, 2 valve 4 stroke single cylinder
Displacement	500 cc
Bore x Stroke	93 mm x 73.6 mm
Alternator Output	660 W @ 7000 RPM

# SPECIFICATIONS

SPORTSMAN 450 HO / HO EPS	
Compression Ratio	10:1
Starting System	Electric
Ignition System	ECU
Idle RPM	1200 +/- 50
Spark Plug Type / Gap	5924 / 0.76-0.92 mm
Lubrication System	Wet Sump
Driving System Type	Automatic PVT (POLARIS Variable Transmission)
Front Suspension	MacPherson strut with 8.2" (21 cm) travel
Rear Suspension	Linear rate with 9.5" (24 cm) travel
Transmission	H/L/N/R/P
Gear Reduction, Low	23.91:1
Gear Reduction, Reverse	21.74:1
Gear Reduction, High	12.79:1
Drive Ratio, Front	3.818:1
Drive Ratio, Rear	3.7:1
Tires/Pressure, Front	24x8-12 / 7 psi (48.3 kPa)
Tires/Pressure, Rear	24x10-12 / 7 psi (48.3 kPa)
Brakes, Front/Rear	Single-Control Hydraulic Disc
Brakes, Auxiliary	Foot-Activated Hydraulic Disc
Brake, Parking	Hydraulic lock, all wheel
Headlight	1 Single Beam on Headlight Pod (50 watt) 2 Single Beam on Bumper (50 watt)
Taillights	8.26 watts
Brake Light	26.9 watts
Instrument Cluster	LCD



**CLUTCHING**

ALTITUDE		SHIFT WEIGHT	DRIVE CLUTCH SPRING	DRIVEN CLUTCH SPRING
Meters (Feet)	0-1800 (0-6000)	25-48 PN 5633217	Red/Blue PN 7043372	Black PN 7041782
	1800-3700 (6000-12000)	28-36 PN 5633115	Blue/Red PN 7043199	Black PN 7041782

**SPORTSMAN 450 HD 2X4**

SPORTSMAN 450 HD 2X4	
Maximum Weight Capacity	485 lbs. (220 kg) (operator, cargo, accessories)
Dry Weight	640 lbs. (290 kg)
Fuel Capacity	4.5 gal. (17 l)
Engine Oil Capacity	2 qts. (1.9 l)
Coolant Capacity	2.7 qts. (2.5 l)
Rear Gearcase Oil Capacity	7.1 oz. (210 ml)
Demand Drive Fluid Capacity	9 oz. (265 ml)
Transmission Oil Capacity	32 oz. (948 ml)
Front Rack/Storage Box Capacity	90 lbs. (40.8 kg)
Rear Rack Capacity	180 lbs. (81.6 kg)
Receiver Hitch Tongue Capacity	120 lbs. (54 kg) (Rear rack capacity and tongue weight not to exceed 180 lbs./81.6 kg)
Hitch Towing Rating	1225 lbs. (555.7 kg)
Unbraked Trailer Towing Capacity*	1786 lbs. (810 kg)
Overall Length	83 in. (211 cm)
Overall Width	48 in. (122 cm)
Overall Height	46 in. (117 cm)
Wheelbase	50.5 in. (128.3 cm)
Ground Clearance	10 in. (25.4 cm)
Minimum Turning Radius	65 in. (165 cm) unloaded

# SPECIFICATIONS

SPORTSMAN 450 HD 2X4	
Engine	Single overhead cam, 2 valve 4 stroke single cylinder
Displacement	500 cc
Bore x Stroke	93 mm x 73.6 mm
Alternator Output	660 W @ 7000 RPM
Compression Ratio	10:1
Starting System	Electric
Ignition System	ECU
Idle RPM	1200 +/- 50
Spark Plug Type / Gap	5924 / 0.76-0.92 mm
Lubrication System	Wet Sump
Driving System Type	Automatic PVT (POLARIS Variable Transmission)
Front Suspension	MacPherson strut with 8.2" (21 cm) travel
Rear Suspension	Linear rate with 9.5" (24 cm) travel
Transmission	H/L/N/R/P
Gear Reduction, Low	23.91:1
Gear Reduction, Reverse	21.74:1
Gear Reduction, High	12.79:1
Drive Ratio, Front	3.818:1
Drive Ratio, Rear	3.7:1
Tires/Pressure, Front	24x8-12 / 7 psi (48.3 kPa)
Tires/Pressure, Rear	24x10-12 / 7 psi (48.3 kPa)
Brakes, Front/Rear	Single-Control Hydraulic Disc
Brakes, Auxiliary	Foot-Activated Hydraulic Disc
Brake, Parking	Hydraulic lock, all wheel
Headlight	1 Single Beam on Headlight Pod (50 watt) 2 Single Beam on Bumper (50 watt)

SPORTSMAN 450 HD 2X4	
Taillights	8.26 watts
Brake Light	26.9 watts
Instrument Cluster	LCD

## CLUTCHING

ALTITUDE		SHIFT WEIGHT	DRIVE CLUTCH SPRING	DRIVEN CLUTCH SPRING
Meters (Feet)	0-1800 (0-6000)	25-48 PN 5633217	Red/Blue PN 7043372	Black PN 7041782
	1800-3700 (6000-12000)	28-36 PN 5633115	Blue/Red PN 7043199	Black PN 7041782

## SPORTSMAN 450 UTILITY EDITION

SPORTSMAN 450 UTILITY EDITION	
Maximum Weight Capacity	485 lbs. (220 kg) (operator, cargo, accessories)
Dry Weight	721 lbs. (327 kg)
Fuel Capacity	4.5 gal. (17 l)
Engine Oil Capacity	2 qts. (1.9 l)
Coolant Capacity	2.7 qts. (2.5 l)
Rear Gearcase Oil Capacity	7.1 oz. (210 ml)
Demand Drive Fluid Capacity	9 oz. (265 ml)
Transmission Oil Capacity	32 oz. (948 ml)
Front Rack/Storage Box Capacity	90 lbs. (40.8 kg)
Rear Rack Capacity	180 lbs. (81.6 kg)
Receiver Hitch Tongue Capacity	120 lbs. (54 kg) (Rear rack capacity and tongue weight not to exceed 180 lbs./81.6 kg)
Hitch Towing Rating	1225 lbs. (555.7 kg)
Unbraked Trailer Towing Capacity*	1786 lbs. (810 kg)
Front Hitch Maximum Towed Load (Level Ground)	850 lbs. (386 kg)

# SPECIFICATIONS

SPORTSMAN 450 UTILITY EDITION	
Front Maximum Vertical Hitch Weight	85 lbs. (39 kg)
Overall Length	83 in. (211 cm)
Overall Width	48 in. (122 cm)
Overall Height	46 in. (117 cm)
Wheelbase	50.5 in. (128.3 cm)
Ground Clearance	10 in. (25.4 cm)
Minimum Turning Radius	65 in. (165 cm) unloaded
Engine	Single overhead cam, 2 valve 4 stroke single cylinder
Displacement	500 cc
Bore x Stroke	93 mm x 73.6 mm
Alternator Output	660 W @ 7000 RPM
Compression Ratio	10:1
Starting System	Electric
Ignition System	ECU
Idle RPM	1200 +/- 50
Spark Plug Type / Gap	5924 / 0.76-0.92 mm
Lubrication System	Wet Sump
Driving System Type	Automatic PVT (POLARIS Variable Transmission)
Front Suspension	MacPherson strut with 8.2" (21 cm) travel
Rear Suspension	Linear rate with 9.5" (24 cm) travel
Transmission	H/L/N/R/P
Gear Reduction, Low	23.91:1
Gear Reduction, Reverse	21.74:1
Gear Reduction, High	12.79:1
Drive Ratio, Front	3.818:1
Drive Ratio, Rear	3.7:1

<b>SPORTSMAN 450 UTILITY EDITION</b>	
Tires/Pressure, Front	24x8-12 / 7 psi (48.3 kPa)
Tires/Pressure, Rear	24x10-12 / 7 psi (48.3 kPa)
Brakes, Front/Rear	Single-Control Hydraulic Disc
Brakes, Auxiliary	Foot-Activated Hydraulic Disc
Brake, Parking	Hydraulic lock, all wheel
Headlight	1 Single Beam on Headlight Pod (50 watt) 2 Single Beam on Bumper (50 watt)
Taillights	8.26 watts
Brake Light	26.9 watts
Instrument Cluster	LCD

## CLUTCHING

<b>ALTITUDE</b>		<b>SHIFT WEIGHT</b>	<b>DRIVE CLUTCH SPRING</b>	<b>DRIVEN CLUTCH SPRING</b>
Meters (Feet)	0-1800 (0-6000)	25-48 PN 5633217	Red/Blue PN 7043372	Black PN 7041782
	1800-3700 (6000-12000)	28-36 PN 5633115	Blue/Red PN 7043199	Black PN 7041782

## SPORTSMAN 570 / 570 EPS / 570 SP

<b>SPORTSMAN 570 / 570 EPS / 570 SP</b>	
Maximum Weight Capacity	485 lbs. (220 kg) (operator, cargo, accessories)
Dry Weight	570: 677 lbs. (307 kg) 570 EPS: 690 lbs. (313 kg) 570 SP: 730 lbs. (331 kg)
Fuel Capacity	4.5 gal. (17 l)
Engine Oil Capacity	2 qts. (1.9 l)
Coolant Capacity	2.7 qts. (2.5 l)
Rear Gearcase Oil Capacity	7.1 oz. (210 ml)
Demand Drive Fluid Capacity	9 oz. (265 ml)

# SPECIFICATIONS

SPORTSMAN 570 / 570 EPS / 570 SP	
Transmission Oil Capacity	32 oz. (948 ml)
Front Rack/Storage Box Capacity	90 lbs. (40.8 kg)
Rear Rack Capacity	180 lbs. (81.6 kg)
Receiver Hitch Tongue Capacity	120 lbs. (55 kg)* (570/570 EPS) 150 lbs. (68 Kg)* (570 SP) *Rear rack capacity and tongue weight not to exceed 180 lbs./81.6 kg
Hitch Towing Rating	1225 lbs. (557 kg) (570/570 EPS) 1500 lbs. (682 kg) (570 SP)
Unbraked Trailer Towing Capacity*	1786 lbs. (810 kg)
Front Hitch Maximum Towed Load (Level Ground)	850 lbs. (386 kg)
Front Maximum Vertical Hitch Weight	85 lbs. (39 kg)
Overall Length	83 in. (211 cm)
Overall Width	48 in. (122 cm)
Overall Height	48 in. (122 cm)
Wheelbase	50.5 in. (128.3 cm)
Ground Clearance	11 in. (28 cm) (570/570 EPS) 12 in. (30.5 cm) (570 SP)
Minimum Turning Radius	65 in. (165 cm) unloaded
Engine	Dual overhead cam, 4 valve 4 stroke single cylinder
Displacement	567 cc
Bore x Stroke	99mm x 73.6mm
Alternator Output	560 W @ 7000 RPM (570/570 EPS) 660 W @ 7000 RPM (570 SP)
Compression Ratio	10:1
Starting System	Electric
Ignition System	ECU
Idle RPM	1200 +/- 50
Spark Plug Type / Gap	MR7F / 0.7-0.8 mm

# SPECIFICATIONS

SPORTSMAN 570 / 570 EPS / 570 SP	
Lubrication System	Wet Sump
Driving System Type	Automatic PVT (POLARIS Variable Transmission)
Front Suspension	MacPherson strut with 8.2" (21 cm) travel (570/570 EPS) Double A-Arm with 8.2" (21 cm) travel (570 SP)
Rear Suspension	Linear rate with 9.5" (24 cm) travel
Transmission	H/L/N/R/P
Gear Reduction, Low	23.91:1
Gear Reduction, Reverse	21.74:1
Gear Reduction, Forward	9.75:1
Drive Ratio, Front	3.82:1 (570/570 EPS) 3.25:1 (570 SP)
Drive Ratio, Rear	3.7:1
Tires/Pressure, Front	25x8-12 / 7 psi (48.3 kPa) (570/570 EPS) 26x8-14 / 7 psi (48.3 kPa) (570 SP)
Tires/Pressure, Rear	25x10-12 / 7 psi (48.3 kPa) (570) 25x11-12 / 7 psi (48.3 kPa) (570 EPS/LE) 26x10-14 / 7 psi (48.3 kPa) (570 SP) 26x11-14 / 7 psi (48.3 kPa) (570 SP LE)
Brakes, Front/Rear	Single-Control Hydraulic Disc
Brakes, Auxiliary	Foot-Activated Hydraulic Disc
Brake, Parking	Hydraulic lock, all wheel
Headlight	1 Single Beam on Headlight Pod (50 watt) 2 Single Beam on Bumper (50 watt)
Taillights	8.26 watts
Brake Light	26.9 watts
Instrument Cluster	LCD
* Based on EU Directive 76/432/EC	

# SPECIFICATIONS

## CLUTCHING

ALTITUDE		SHIFT WEIGHT	DRIVE CLUTCH SPRING	DRIVEN CLUTCH SPRING	HELIX*
Meters (Feet)	0-1800 (0-6000)	25-52G PN 5632409	Black PN 7043594	EBS Black PN 7044505	EBS PN 3235784
	1800-3700 (6000-12000)	25-48 PN 5633217	Black PN 7043594	Non-EBS Red PN 3234451	Non-EBS PN 5132344
*EBS models require no helix/spring adjustment					

## SPORTSMAN 570 HD

SPORTSMAN 570 HD	
Maximum Weight Capacity	485 lbs. (220 kg) (operator, cargo, accessories)
Dry Weight	677 lbs. (307 kg)
Fuel Capacity	4.5 gal. (17 l)
Engine Oil Capacity	2 qts. (1.9 l)
Coolant Capacity	2.7 qts. (2.5 l)
Rear Gearcase Oil Capacity	7.1 oz. (210 ml)
Demand Drive Fluid Capacity	9 oz. (265 ml)
Transmission Oil Capacity	32 oz. (948 ml)
Front Rack/Storage Box Capacity	90 lbs. (40.8 kg)
Rear Rack Capacity	180 lbs. (81.6 kg)
Receiver Hitch Tongue Capacity	120 lbs. (55 kg)* *Rear rack capacity and tongue weight not to exceed 180 lbs./81.6 kg
Hitch Towing Rating	1225 lbs. (557 kg)
Unbraked Trailer Towing Capacity*	1786 lbs. (810 kg)
Overall Length	83 in. (211 cm)
Overall Width	48 in. (122 cm)
Overall Height	48 in. (122 cm)
Wheelbase	50.5 in. (128.3 cm)



# SPECIFICATIONS

SPORTSMAN 570 HD	
Ground Clearance	11 in. (28 cm)
Minimum Turning Radius	65 in. (165 cm) unloaded
Engine	Dual overhead cam, 4 valve 4 stroke single cylinder
Displacement	567 cc
Bore x Stroke	99mm x 73.6mm
Alternator Output	560 W @ 7000 RPM
Compression Ratio	10:1
Starting System	Electric
Ignition System	ECU
Idle RPM	1200 +/- 50
Spark Plug Type / Gap	MR7F / 0.7-0.8 mm
Lubrication System	Wet Sump
Driving System Type	Automatic PVT (POLARIS Variable Transmission)
Front Suspension	MacPherson strut with 8.2" (21 cm) travel
Rear Suspension	Linear rate with 9.5" (24 cm) travel
Transmission	H/L/N/R/P
Gear Reduction, Low	23.91:1
Gear Reduction, Reverse	21.74:1
Gear Reduction, Forward	9.75:1
Drive Ratio, Front	3.82:1
Tires/Pressure, Front	25x8-12 / 7 psi (48.3 kPa)
Tires/Pressure, Rear	25x10-12 / 7 psi (48.3 kPa)
Brakes, Front/Rear	Single-Control Hydraulic Disc
Brakes, Auxiliary	Foot-Activated Hydraulic Disc
Brake, Parking	Hydraulic lock, all wheel
Headlight	1 Single Beam on Headlight Pod (50 watt)

## SPECIFICATIONS

SPORTSMAN 570 HD	
	2 Single Beam on Bumper (50 watt)
Taillights	8.26 watts
Brake Light	26.9 watts
Instrument Cluster	LCD
* Based on EU Directive 76/432/EC	

## CLUTCHING

ALTITUDE		SHIFT WEIGHT	DRIVE CLUTCH SPRING	DRIVEN CLUTCH SPRING	HELIX*
Meters (Feet)	0-1800 (0-6000)	25-52G PN 5632409	Black PN 7043594	EBS Black PN 7044505	EBS PN 3235784
	1800-3700 (6000-12000)	25-48 PN 5633217	Black PN 7043594	Non-EBS Red PN 3234451	Non-EBS PN 5132344
*EBS models require no helix/spring adjustment					

## SPORTSMAN 570 UTILITY EDITION

SPORTSMAN 570 UTILITY EDITION	
Maximum Weight Capacity	485 lbs. (220 kg) (operator, cargo, accessories)
Dry Weight	755 lbs. (342 kg)
Fuel Capacity	4.5 gal. (17 l)
Engine Oil Capacity	2 qts. (1.9 l)
Coolant Capacity	2.7 qts. (2.5 l)
Rear Gearcase Oil Capacity	7.1 oz. (210 ml)
Demand Drive Fluid Capacity	9 oz. (265 ml)
Transmission Oil Capacity	32 oz. (948 ml)
Front Rack/Storage Box Capacity	90 lbs. (40.8 kg)
Rear Rack Capacity	180 lbs. (81.6 kg)
Receiver Hitch Tongue Capacity	120 lbs. (55 kg)* *Rear rack capacity and tongue weight not to exceed 180 lbs./81.6 kg

# SPECIFICATIONS

SPORTSMAN 570 UTILITY EDITION	
Hitch Towing Rating	1225 lbs. (557 kg)
Unbraked Trailer Towing Capacity*	1786 lbs. (810 kg)
Overall Length	83 in. (211 cm)
Overall Width	48 in. (122 cm)
Overall Height	48 in. (122 cm)
Wheelbase	50.5 in. (128.3 cm)
Ground Clearance	11 in. (28 cm)
Minimum Turning Radius	65 in. (165 cm) unloaded
Engine	Dual overhead cam, 4 valve 4 stroke single cylinder
Displacement	567 cc
Bore x Stroke	99mm x 73.6mm
Alternator Output	560 W @ 7000 RPM
Compression Ratio	10:1
Starting System	Electric
Ignition System	ECU
Idle RPM	1200 +/- 50
Spark Plug Type / Gap	MR7F / 0.7-0.8 mm
Lubrication System	Wet Sump
Driving System Type	Automatic PVT (POLARIS Variable Transmission)
Front Suspension	MacPherson strut with 8.2" (21 cm) travel
Rear Suspension	Linear rate with 9.5" (24 cm) travel
Transmission	H/L/N/R/P
Gear Reduction, Low	23.91:1
Gear Reduction, Reverse	21.74:1
Gear Reduction, Forward	11.12:1
Drive Ratio, Front	3.82:1

## SPECIFICATIONS

SPORTSMAN 570 UTILITY EDITION	
Tires/Pressure, Front	25x8-12 / 7 psi (48.3 kPa)
Tires/Pressure, Rear	25x10-12 / 7 psi (48.3 kPa)
Brakes, Front/Rear	Single-Control Hydraulic Disc
Brakes, Auxiliary	Foot-Activated Hydraulic Disc
Brake, Parking	Hydraulic lock, all wheel
Headlight	1 Single Beam on Headlight Pod (50 watt) 2 Single Beam on Bumper (50 watt)
Taillights	8.26 watts
Brake Light	26.9 watts
Instrument Cluster	LCD
* Based on EU Directive 76/432/EC	

## CLUTCHING

ALTITUDE		SHIFT WEIGHT	DRIVE CLUTCH SPRING	DRIVEN CLUTCH SPRING	HELIX*
Meters (Feet)	0-1800 (0-6000)	25-52G PN 5632409	Black PN 7043594	EBS Black PN 7044505	EBS PN 3235784
	1800-3700 (6000-12000)	25-48 PN 5633217	Black PN 7043594	Non-EBS Red PN 3234451	Non-EBS PN 5132344
*EBS models require no helix/spring adjustment					

## SPORTSMAN TOURING 570 / 570 EPS / 570 SP

SPORTSMAN TOURING 570 / 570 EPS / 570 SP	
Maximum Weight Capacity	485 lbs. (220 kg) (operator, cargo, accessories)
Dry Weight	570 Tour: 708 lbs. (321 kg) 570 Tour EPS: 722 lbs. (327 kg) 570 Tour SP: 759 lbs. (344 kg)
Fuel Capacity	6.25 gal. (23.7 l)
Engine Oil Capacity	2 qts. (1.9 l)
Coolant Capacity	2.7 qts. (2.5 l)

# SPECIFICATIONS

SPORTSMAN TOURING 570 / 570 EPS / 570 SP	
Rear Gearcase Oil Capacity	7.1 oz. (210 ml)
Demand Drive Fluid Capacity	9 oz. (265 ml)
Transmission Oil Capacity	32 oz. (948 ml)
Front Rack/Storage Box Capacity	90 lbs. (40.8 kg)
Rear Rack Capacity	180 lbs. (81.6 kg)
Receiver Hitch Tongue Capacity	120 lbs. (55 kg)* (570/570 EPS) 150 lbs. (68 Kg)* (570 SP) *Rear rack capacity and tongue weight not to exceed 180 lbs./81.6 kg
Hitch Towing Rating	1225 lbs. (557 kg) (570/570 EPS) 1500 lbs. (682 kg) (570 SP)
Unbraked Trailer Towing Capacity*	1786 lbs. (810 kg)
Front Hitch Maximum Towed Load (Level Ground)	850 lbs. (386 kg)
Front Maximum Vertical Hitch Weight	85 lbs. (39 kg)
Overall Length	86 in. (218.4 cm)
Overall Width	48 in. (122 cm)
Overall Height	48 in. (122 cm)
Wheelbase	56 in. (142.2 cm)
Ground Clearance	11 in. (28 cm) (570/570 EPS) 12 in. (30.5 cm) (570 SP)
Minimum Turning Radius	82 in. (208.3 cm) unloaded
Engine	Dual overhead cam, 4 valve 4 stroke single cylinder
Displacement	567 cc
Bore x Stroke	99mm x 73.6mm
Alternator Output	560 W @ 7000 RPM (570/570 EPS) 660 W @ 7000 RPM (570 SP)
Compression Ratio	10:1
Starting System	Electric
Ignition System	ECU

# SPECIFICATIONS

SPORTSMAN TOURING 570 / 570 EPS / 570 SP	
Idle RPM	1200 +/- 50
Spark Plug Type / Gap	MR7F / 0.7-0.8 mm
Lubrication System	Wet Sump
Driving System Type	Automatic PVT (POLARIS Variable Transmission)
Front Suspension	MacPherson strut with 8.2" (21 cm) travel (570/570 EPS) Double A-Arm with 8.2" (21 cm) travel (570 SP)
Rear Suspension	Linear rate with 9.5" (24 cm) travel
Transmission	H/L/N/R/P
Gear Reduction, Low	23.91:1
Gear Reduction, Reverse	21.74:1
Gear Reduction, Forward	9.75:1
Drive Ratio, Front	3.82:1 (570/570 EPS) 3.25:1 (570 SP)
Drive Ratio, Rear	3.7:1
Tires/Pressure, Front	25x8-12 / 7 psi (48.3 kPa) (570/570 EPS) 26x8-14 / 7 psi (48.3 kPa) (570 SP)
Tires/Pressure, Rear	25x10-12 / 7 psi (48.3 kPa) (570) 25x11-12 / 7 psi (48.3 kPa) (570 EPS/LE) 26x10-14 / 7 psi (48.3 kPa) (570 SP) 26x11-14 / 7 psi (48.3 kPa) (570 SP LE)
Brakes, Front/Rear	Single-Control Hydraulic Disc
Brakes, Auxiliary	Foot-Activated Hydraulic Disc
Brake, Parking	Hydraulic lock, all wheel
Headlight	1 Single Beam on Headlight Pod (50 watt) 2 Single Beam on Bumper (50 watt)
Taillights	8.26 watts
Brake Light	26.9 watts
Instrument Cluster	LCD
* Based on EU Directive 76/432/EC	

**CLUTCHING**

ALTITUDE		SHIFT WEIGHT	DRIVE CLUTCH SPRING	DRIVEN CLUTCH SPRING	HELIX*
Meters (Feet)	0-1800 (0-6000)	25-52G PN 5632409	Black PN 7043594	EBS Black PN 7044505	EBS PN 3235784
	1800-3700 (6000-12000)	25-48 PN 5633217	Black PN 7043594	Non-EBS Red PN 3234451	Non-EBS PN 5132344

\*EBS models require no helix/spring adjustment

**SPORTSMAN X2 570 EPS**

SPORTSMAN X2 570 EPS	
Maximum Weight Capacity	485 lbs. (220 kg) (operator, cargo, accessories)
Dry Weight	767 lbs. (347.9 kg)
Fuel Capacity	6.25 gal. (23.7 l)
Engine Oil Capacity	2 qts. (1.9 l)
Coolant Capacity	2.7 qts. (2.5 l)
Rear Gearcase Oil Capacity	7.1 oz. (210 ml)
Demand Drive Fluid Capacity	9 oz. (265 ml)
Transmission Oil Capacity	32 oz. (948 ml)
Front Rack/Storage Box Capacity	90 lbs. (40.8 kg)
Rear Rack Capacity	180 lbs. (81.6 kg)
Hitch Tongue Weight	120 lbs. (55 kg)* *Rear rack capacity and tongue weight not to exceed 180 lbs./81.6 kg
Hitch Towing Rating	1225 lbs. (557 kg)
Unbraked Trailer Towing Capacity*	1786 lbs. (810 kg)
Overall Length	89 in. (226 cm)
Overall Width	48 in. (122 cm)
Overall Height	48 in. (122 cm)
Wheelbase	56 in. (142.2 cm)

# SPECIFICATIONS

SPORTSMAN X2 570 EPS	
Ground Clearance	11 in. (28 cm)
Minimum Turning Radius	65 in. (165 cm) unloaded
Engine	Dual overhead cam, 4 valve 4 stroke single cylinder
Displacement	567 cc
Bore x Stroke	99mm x 73.6mm
Alternator Output	560 W @ 7000 RPM
Compression Ratio	10:1
Starting System	Electric
Ignition System	ECU
Idle RPM	1200 +/- 50
Spark Plug Type / Gap	MR7F / 0.7-0.8 mm
Lubrication System	Wet Sump
Driving System Type	Automatic PVT (POLARIS Variable Transmission)
Front Suspension	MacPherson strut with 8.2" (21 cm) travel
Rear Suspension	Linear rate with 9.5" (24 cm) travel
Transmission	H/L/N/R/P
Gear Reduction, Low	23.91:1
Gear Reduction, Reverse	21.74:1
Gear Reduction, Forward	9.75:1
Drive Ratio, Front	3.82:1
Tires/Pressure, Front	25x8-12 / 7 psi (48.3 kPa)
Tires/Pressure, Rear	25x11-12 / 7 psi (48.3 kPa)
Brakes, Front/Rear	Single-Control Hydraulic Disc
Brakes, Auxiliary	Foot-Activated Hydraulic Disc
Brake, Parking	Hydraulic lock, all wheel
Headlight	1 Single Beam on Headlight Pod (50 watt)



# SPECIFICATIONS

SPORTSMAN X2 570 EPS	
	2 Single Beam on Bumper (50 watt)
Taillights	8.26 watts
Brake Light	26.9 watts
Instrument Cluster	LCD
* Based on EU Directive 76/432/EC	

## CLUTCHING

ALTITUDE		SHIFT WEIGHT	DRIVE CLUTCH SPRING	DRIVEN CLUTCH SPRING	HELIX*
Meters (Feet)	0-1800 (0-6000)	25-52G PN 5632409	Black PN 7043594	EBS Black PN 7044505	EBS PN 3235784
	1800-3700 (6000-12000)	25-48 PN 5633217	Black PN 7043594	Non-EBS Red PN 3234451	Non-EBS PN 5132344
*EBS models require no helix/spring adjustment					

## UTE 570

UTE 570	
Maximum Weight Capacity	705 lbs. (320 kg) (operator, cargo, accessories)
Dry Weight	780 lbs. (354 kg)
Fuel Capacity	6.25 gal. (23.7 l)
Engine Oil Capacity	2 qts. (1.9 l)
Coolant Capacity	2.7 qts. (2.5 l)
Rear Gearcase Oil Capacity	7.1 oz. (210 ml)
Demand Drive Fluid Capacity	9 oz. (265 ml)
Transmission Oil Capacity	32 oz. (948 ml)
Front Rack/Storage Box Capacity	90 lbs. (40.8 kg)
Rear Rack/Cargo Box Capacity	400 lbs. (181.4 kg)
Hitch Tongue Weight	120 lbs. (55 kg)* *Rear rack capacity and tongue weight not to exceed 180 lbs./81.6 kg

# SPECIFICATIONS

UTE 570	
Hitch Towing Rating	1225 lbs. (557 kg)
Unbraked Trailer Towing Capacity*	1786 lbs. (810 kg)
Overall Length	89 in. (226 cm)
Overall Width	48 in. (122 cm)
Overall Height	48 in. (122 cm)
Wheelbase	56 in. (142.2 cm)
Ground Clearance	11 in. (28 cm)
Minimum Turning Radius	82 in. (208.3 cm) unloaded
Engine	Dual overhead cam, 4 valve 4 stroke single cylinder
Displacement	567 cc
Bore x Stroke	99mm x 73.6mm
Alternator Output	560 W @ 7000 RPM
Compression Ratio	10:1
Starting System	Electric
Ignition System	ECU
Idle RPM	1200 +/- 50
Spark Plug Type / Gap	MR7F / 0.7-0.8 mm
Lubrication System	Wet Sump
Driving System Type	Automatic PVT (POLARIS Variable Transmission)
Front Suspension	MacPherson strut with 8.2" (21 cm) travel
Rear Suspension	Linear rate with 9.5" (24 cm) travel
Transmission	H/L/N/R/P
Gear Reduction, Low	23.91:1
Gear Reduction, Reverse	21.74:1
Gear Reduction, Forward	9.75:1
Drive Ratio, Front	3.82:1

# SPECIFICATIONS

## UTE 570

Tires/Pressure, Front	25x8-12 / 7 psi (48.3 kPa)
Tires/Pressure, Rear	25x12.5-12 / 7 psi (48.3 kPa)
Brakes, Front/Rear	Single-Control Hydraulic Disc
Brakes, Auxiliary	Foot-Activated Hydraulic Disc
Brake, Parking	Hydraulic lock, all wheel
Headlight	1 Single Beam on Headlight Pod (50 watt) 2 Single Beam on Bumper (50 watt)
Taillights	8.26 watts
Brake Light	26.9 watts
Instrument Cluster	LCD
* Based on EU Directive 76/432/EC	

## CLUTCHING

ALTITUDE		SHIFT WEIGHT	DRIVE CLUTCH SPRING	DRIVEN CLUTCH SPRING	HELIX*
Meters (Feet)	0-1800 (0-6000)	25-52G PN 5632409	Black PN 7043594	EBS Black PN 7044505	EBS PN 3235784
	1800-3700 (6000-12000)	25-48 PN 5633217	Black PN 7043594	Non-EBS Red PN 3234451	Non-EBS PN 5132344
*EBS models require no helix/spring adjustment					

## SPORTSMAN® 6X6 570

### SPORTSMAN® 6X6 570

Maximum Weight Capacity	1115 lbs. (505.8 kg) (includes operator, passenger, cargo, accessories)
Dry Weight	1095 lbs. (496.7 kg)
Fuel Capacity	6.25 gal. (23.7 l)
Engine Oil Capacity	2 qts. (1.9 l)
Coolant Capacity	2.7 qts. (2.5 l)
Rear Gearcase Oil Capacity	7.1 oz. (210 ml)

# SPECIFICATIONS

<b>SPORTSMAN® 6X6 570</b>	
Demand Drive Fluid Capacity	9 oz. (265 ml)
Transmission Oil Capacity	33.8 oz. (1000 ml)
Front Rack/Storage Box Capacity	90 lbs. (40.8 kg)
Rear Rack Capacity	180 lbs. (81 kg)
Cargo Box Capacity	800 lbs. (362 kg)
Hitch Tongue Weight	150 lbs. (68 kg) (Rear box capacity and tongue weight not to exceed 400 lbs./181 kg)
Hitch Towing Rating	1500 lbs. (680 kg)
Unbraked Trailer Towing Capacity*	2127 lbs. (964 kg)
Overall Length	116 in. (294 cm)
Overall Width	49 in. (124 cm)
Overall Height	49 in. (124 cm)
Wheelbase	84 in. (213 cm)
Ground Clearance	11.5 in. (29 cm)
Minimum Turning Radius	160 in. (406 cm) (unloaded)
Rear Gearcase Oil Capacity	5 oz. (150 ml)
Engine	Dual overhead cam, 4 valve 4 stroke single cylinder
Displacement	567 cc
Bore x Stroke	99mm x 73.6mm
Alternator Output	660 W @ 7000 RPM
Compression Ratio	10:1
Starting System	Electric
Ignition System	ECU
Idle RPM	1200 +/- 50
Spark Plug Type / Gap	NGK MR7F / 0.7-0.8 mm
Lubrication System	Wet Sump

# SPECIFICATIONS

SPORTSMAN® 6X6 570	
Driving System Type	Automatic PVT (POLARIS Variable Transmission)
Front Suspension	MacPherson strut with 8.2" (21 cm) travel
Rear Suspension	Linear rate with 9.5" (24 cm) travel
Transmission	H/L/N/R/P
Gear Reduction, Low	23.91:1
Gear Reduction, Reverse	21.74:1
Gear Reduction, Forward	9.75:1
Drive Ratio, Front	3.82:1
Tires/Pressure, Front	26x8-12 / 7 psi (48.3 kPa)
Tires/Pressure, Rear	26x11-12 / 10 psi (68.9 kPa)
Brakes, Front/Rear	Single-Control Hydraulic Disc
Brakes, Auxiliary	Foot-Activated Hydraulic Disc
Brake, Parking	Hydraulic lock, all wheel
Headlight	1 Single Beam on Headlight Pod (50 watt) 2 Single Beam on Bumper (50 watt)
Taillights	8.26 watts
Brake Light	26.9 watts
Instrument Cluster	LCD
* Based on EU Directive 76/432/EC	

## CLUTCHING

ALTITUDE		SHIFT WEIGHT	DRIVE CLUTCH SPRING	DRIVEN CLUTCH SPRING	HELIX*
Meters (Feet)	0-1800 (0-6000)	25-52G PN 5632409	Black PN 7043594	EBS Black PN 7044505	EBS PN 3235784
	1800-3700 (6000-12000)	25-48 PN 5633217	Black PN 7043594	Non-EBS Red PN 3234451	Non-EBS PN 5132344
*EBS models require no helix/spring adjustment					



# POLARIS PRODUCTS

## LUBRICANTS / SERVICE PRODUCTS

PRODUCT	SIZE (QUANTITY)	PART NUMBER
Fogging Oil	12 oz aerosol (12)	2870791
	1 qt (12)	2871517
PS-4	1 qt (12)	2876244
	2 qt (8)	2877490
	1 gal (4)	2876245
PS-4 Extreme Duty	1 qt (12)	2878920
	2 qt (8)	2878922
	1 gal (4)	2878919
AGL	1 qt (12)	2878068
	1 gal (4)	2878069
Pump for Gallon Jug	3.8 l	2870465
Demand Drive	1 qt (12)	2877922
	2.5 gal (2)	2877923
Antifreeze / Coolant	1 qt (12)	2880514
	1 gal (6)	2880513
Grease Gun Kit, Premium All Season	—	2871312
All Season Grease	Four 3 oz packs (6)	2871322
	14 oz cartridge	2871423
Premium Starter Grease	—	2871460
U-Joint Grease	3 oz tube (24)	2871515
	14 oz cartridge	2871551
Dielectric Grease (Nyogel™)	—	2871329
Carbon Clean	12 oz bottle (12)	2871326
Fuel Stabilizer	16 oz (12)	2870652
	2.5 gal (2)	2872280
DOT 4 Brake Fluid	—	2872189
Loctite™ 565 Thread Sealant	—	2871956
POLARIS Battery Tender™ Charger	—	2859044





## TROUBLESHOOTING

### DRIVE BELT WEAR/BURN

POSSIBLE CAUSE	SOLUTION
Driving onto a pickup or tall trailer in high range	Use low range during loading.
Starting out going up a steep incline	Use low range.
Driving at low RPM or ground speed (3-7 MPH)	Drive at a higher speed or use low range more frequently.
Insufficient warm-up at low ambient temperatures	Warm the engine at least 5 minutes. With the transmission in neutral, advance the throttle to about 1/8 throttle in short bursts, 5 to 7 times. The belt will become more flexible and prevent belt burning.
Slow/easy clutch engagement	Use the throttle quickly and effectively.
Towing/pushing at low RPM/low ground speed	Use low range only.
Utility use/plowing	Use low range only.
Stuck in mud or snow	Shift the transmission to low range and carefully use fast, aggressive throttle application to engage clutch. <b>WARNING: Excessive throttle may cause loss of control and vehicle rollover.</b>
Climbing over large objects from a stopped position	Shift the transmission to low range and carefully use fast, brief, aggressive throttle application to engage clutch. <b>WARNING: Excessive throttle may cause loss of control and vehicle rollover.</b>
Belt slippage from water or snow ingestion into the PVT system	Dry out the PVT. Prevent water from entering the PVT intake duct. See Intake Pre-Filters for more information. Inspect clutch seals for damage if repeated leaking occurs.
Clutch malfunction	Your dealer can assist.
Poor engine performance	Check for fouled plug or foreign material in gas tank or fuel lines. Your POLARIS dealer can assist.
Slippage from failure to warm up belt	Always warm up the belt by operating below 30 mph for one mile (5 miles or more when temperature is below freezing).
Wrong or missing belt	Install the recommended belt.
Improper break-in	Always break in a new belt and/or clutch.

## TROUBLESHOOTING

---

### ENGINE DOESN'T TURN OVER

POSSIBLE CAUSE	SOLUTION
Low battery voltage	Recharge the battery to 12.8 VDC
Loose battery connections	Check all connections and tighten
Loose solenoid connections	Check all connections and tighten
Loose electronic control box connections	Inspect, clean, reinstall connectors

### ENGINE TURNS OVER, FAILS TO START

POSSIBLE CAUSE	SOLUTION
Out of fuel	Refuel
Water is present in fuel	Drain the fuel system and refuel
Old or non-recommended fuel	Replace with fresh recommended fuel
Fouled or defective spark plug	Inspect plug and replace if necessary
No spark to spark plug	Inspect plug and replace if necessary
Water or fuel in crankcase	Your authorized dealer can assist
Low battery voltage	Recharge the battery to 12.8 VDC
Mechanical failure	Your authorized dealer can assist

### ENGINE BACKFIRES

POSSIBLE CAUSE	SOLUTION
Weak spark from spark plug	Inspect, clean and/or replace spark plug
Incorrect spark plug gap or heat range	Set gap to specs or replace plug
Old or non-recommended fuel	Replace with fresh recommended fuel
Incorrectly installed spark plug wires	Your authorized dealer can assist

POSSIBLE CAUSE	SOLUTION
Mechanical failure	Your authorized dealer can assist
Loose ignition connections	Check all connections and tighten
Water present in fuel	Replace with fresh recommended fuel

## ENGINE PINGS OR KNOCKS

POSSIBLE CAUSE	SOLUTION
Poor quality or low octane fuel	Replace with recommended fuel
Incorrect spark plug gap or heat range	Set gap to specs or replace plug

## ENGINE RUNS IRREGULARLY, STALLS OR MISFIRES

POSSIBLE CAUSE	SOLUTION
Fouled or defective spark plug	Inspect, clean and/or replace spark plug
Worn or defective spark plug wires	Your authorized dealer can assist
Incorrect spark plug gap or heat range	Set gap to specs or replace plug
Loose ignition connections	Check all connections and tighten
Water present in fuel	Replace with new fuel
Low battery voltage	Recharge battery to 12.8 VDC
Incorrect fuel	Replace with recommended fuel
Clogged air filter	Inspect and clean or replace
Clogged intake pre-filter	Inspect and clean (with soapy water) or replace
Other mechanical failure	Your authorized dealer can assist

## TROUBLESHOOTING

---

### ENGINE STOPS OR LOSES POWER

POSSIBLE CAUSE	SOLUTION
Out of fuel	Refuel
Kinked or plugged fuel vent line	Inspect and replace
Water is present in fuel	Replace with new fuel
Fouled or defective spark plug	Inspect, clean and/or replace spark plug
Worn or defective spark plug wires	Your authorized dealer can assist
Incorrect spark plug gap or heat range	Set gap to specs or replace plug
Loose ignition connections	Check all connections and tighten
Low battery voltage	Recharge the battery to 12.8 VDC
Incorrect fuel	Replace with fresh recommended fuel
Clogged air filter	Inspect and clean or replace
Clogged intake pre-filter	Inspect and clean (with soapy water) or replace
Other mechanical failure	Your authorized dealer can assist
Overheated engine	Clean radiator screen and core, clean engine exterior. Your dealer can assist.

## WARRANTY

### LIMITED WARRANTY

POLARIS Industries Inc., 2100 Highway 55, Medina, MN 55340 (POLARIS) gives a SIX MONTH LIMITED WARRANTY on all components of your POLARIS vehicle against defects in material or workmanship. POLARIS further warrants that the spark arrester in this product will meet the efficiency requirements of USFS standard 5100-1C for at least 1000 hours when subjected to normal use and when maintenance and installation are in accordance with POLARIS recommendations.

This warranty covers parts and labor charges for repair or replacement of defective parts and begins on the date of purchase by the original retail purchaser. This warranty is transferable to another owner during the warranty period through a POLARIS dealer, or other qualified person, but any such transfer will not extend the original term of the warranty. The duration of this warranty may vary by international region based upon local laws and regulations.

## REGISTRATION

At the time of sale, the Warranty Registration Form must be completed by your dealer and submitted to POLARIS within ten days of purchase. Upon receipt of this registration, POLARIS will record the registration for warranty. No verification of registration will be sent to the purchaser as the copy of the Warranty Registration Form will be your proof of warranty coverage. If you have not signed the original registration and received the customer copy, please contact your dealer immediately. **NO WARRANTY COVERAGE WILL BE ALLOWED UNLESS YOUR VEHICLE IS REGISTERED WITH POLARIS.** Initial dealer preparation and set-up of your vehicle is very important in ensuring trouble-free operation. Purchasing a machine in the crate or without proper dealer set-up will void your warranty coverage.

### WARRANTY COVERAGE AND EXCLUSIONS

#### LIMITATIONS OF WARRANTIES AND REMEDIES

This POLARIS limited warranty excludes any failures that are not caused by a defect in material or workmanship. THIS WARRANTY DOES NOT COVER CLAIMS OF DEFECTIVE DESIGN. This warranty also does not cover acts of God, accidental damage, normal wear and tear, abuse or improper handling. This warranty also does not cover any vehicle, component, or part that has been altered structurally, modified, neglected, improperly maintained or used for racing, competition or purposes other than for which it was designed.

This warranty excludes damages or failures resulting from improper lubrication; improper engine timing; improper fuel; surface imperfections caused by external stress, heat, cold or contamination; operator error or abuse; improper component alignment, tension, adjustment or altitude compensation; snow, water, dirt or other foreign substance ingestion/contamination; improper maintenance; modified components; use of aftermarket or unapproved components, accessories, or attachments; use of unapproved software or calibration; unauthorized repairs; or repairs made after the warranty period expires or by an unauthorized repair center.

This warranty excludes damages or failures caused by abuse, accident, fire, or any other cause other than a defect in materials or workmanship and provides no coverage for consumable components, general wear items, or any parts exposed to friction surfaces, stresses, environmental conditions and/or contamination for which they were not designed or not intended, including but not limited to the following items:

- Wheels and tires
- Suspension components
- Brake components
- Seat components
- Clutches and components
- Steering components
- Batteries
- Light bulbs/Sealed beam lamps
- Filters
- Lubricants
- Bushings
- Finished and unfinished surfaces
- Carburetor/Throttle body components
- Engine components
- Drive belts
- Hydraulic components and fluids
- Circuit breakers/Fuses
- Electronic components
- Spark plugs
- Sealants
- Coolants
- Bearings

## LUBRICANTS AND FLUIDS

1. Mixing oil brands or using non-recommended oil may cause engine damage. We recommend the use of POLARIS engine oil.
2. Damage or failure resulting from the use of non-recommended lubricants or fluids is not covered by this warranty.

This warranty provides no coverage for personal loss or expense, including mileage, transportation costs, hotels, meals, shipping or handling fees, product pick-up or delivery, replacement rentals, loss of product use, loss of profits, or loss of vacation or personal time.

THE EXCLUSIVE REMEDY FOR BREACH OF THIS WARRANTY SHALL BE, AT POLARIS' OPTION, REPAIR OR REPLACEMENT OF ANY DEFECTIVE MATERIALS, COMPONENTS, OR PRODUCTS. THE REMEDIES SET FORTH IN THIS WARRANTY ARE THE ONLY REMEDIES AVAILABLE TO ANY PERSON FOR BREACH OF THIS WARRANTY. POLARIS SHALL HAVE NO LIABILITY TO ANY PERSON FOR INCIDENTAL, CONSEQUENTIAL OR SPECIAL DAMAGES OF ANY DESCRIPTION, WHETHER ARISING OUT OF EXPRESS OR IMPLIED WARRANTY OR ANY OTHER CONTRACT, NEGLIGENCE, OR OTHER TORT OR OTHERWISE. THIS EXCLUSION OF CONSEQUENTIAL, INCIDENTAL, AND SPECIAL DAMAGES IS INDEPENDENT FROM AND SHALL SURVIVE ANY FINDING THAT THE EXCLUSIVE REMEDY FAILED OF ITS ESSENTIAL PURPOSE.

THE IMPLIED WARRANTY OF FITNESS FOR A PARTICULAR PURPOSE IS EXCLUDED FROM THIS LIMITED WARRANTY. ALL OTHER IMPLIED WARRANTIES (INCLUDING BUT NOT LIMITED TO THE IMPLIED WARRANTY OF MERCHANTABILITY) ARE LIMITED IN DURATION TO THE ABOVE SIX MONTH WARRANTY PERIOD. POLARIS DISCLAIMS ALL EXPRESS WARRANTIES NOT STATED IN THIS WARRANTY. SOME STATES DO NOT PERMIT THE EXCLUSION OR LIMITATION OF INCIDENTAL OR CONSEQUENTIAL DAMAGES OR ALLOW LIMITATIONS ON THE DURATION OF IMPLIED WARRANTIES, SO THE ABOVE LIMITATIONS MAY NOT APPLY TO YOU IF INCONSISTENT WITH CONTROLLING STATE LAW.

## WARRANTY

---

### **HOW TO OBTAIN WARRANTY SERVICE**

If your vehicle requires warranty service, you must take it to a POLARIS Servicing Dealer. When requesting warranty service you must present your copy of the Warranty Registration Form to the dealer. (THE COST OF TRANSPORTATION TO AND FROM THE DEALER IS YOUR RESPONSIBILITY.) POLARIS suggests that you use your original selling dealer; however, you may use any POLARIS Servicing Dealer to perform warranty service.

### **IN THE COUNTRY WHERE YOUR PRODUCT WAS PURCHASED:**

Warranty or Service Bulletin repairs must be done by an authorized POLARIS dealer, or other qualified person. If you move or are traveling within the country where your product was purchased, Warranty and Service Bulletin repairs may be requested from any authorized POLARIS dealer, or other qualified person, that sells the same line as your product.

### **OUTSIDE THE COUNTRY WHERE YOUR PRODUCT WAS PURCHASED:**

If you are traveling temporarily outside the country where your product was purchased, you should take your product to an authorized POLARIS dealer, or other qualified person. You must show the dealer photo identification from the country of the selling dealer's authorized location as proof of residence. Upon residence verification, the servicing dealer will be authorized to perform the warranty repair.

### **IF YOU MOVE:**

If you move to another country, be sure to contact POLARIS Customer Assistance and the customs department of the destination country before you move. Product importation rules vary considerably from country to country. You may be required to present documentation of your move to POLARIS in order to continue your warranty coverage. You may also be required to obtain documentation from POLARIS in order to register your product in your new country. You should warranty register your product at a local POLARIS dealer in your new country immediately after you move to continue your warranty coverage and to ensure that you receive information and notices regarding your vehicle.

### **IF YOU PURCHASE FROM A PRIVATE PARTY:**

If you purchase a POLARIS product from a private party, to be kept and used outside of the country in which the product was originally purchased, all warranty coverage will be denied. You must nonetheless register your product under your name and address with a local POLARIS dealer in your country to ensure that you receive safety information and notices regarding your product.



## EXPORTED PRODUCTS

EXCEPT WHERE SPECIFICALLY REQUIRED BY LAW, THERE IS NO WARRANTY OR SERVICE BULLETIN COVERAGE ON THIS PRODUCT IF IT IS SOLD OUTSIDE THE COUNTRY OF THE SELLING DEALER'S AUTHORIZED LOCATION. This policy does not apply to products that have received authorization for export from POLARIS. Dealers may not give authorization for export. You should consult an authorized dealer to determine this product's warranty or service coverage if you have any questions. This policy does not apply to products registered to government officials or military personnel on assignment outside the country of the selling dealer's authorized location. This policy does not apply to Safety Bulletins.

## NOTICE

If your product is registered outside of the country where it was purchased and you have not followed the procedure set above, your product will no longer be eligible for warranty or service bulletin coverage of any kind, other than safety bulletins. Products registered to government officials or military personnel on assignment outside of the country where the product was purchased will continue to be covered by the Limited Warranty.

Please work with your dealer to resolve any warranty issues. Should your dealer require any additional assistance, they will contact the appropriate person at POLARIS.

This warranty gives you specific legal rights, and you may also have other rights which vary from state to state or in different countries. If any of the above terms are void because of federal, state, local law, all other warranty terms will remain in effect.

### ***For questions call POLARIS Customer Assistance:***

United States & Canada: 1-800-POLARIS (1-800-765-2747)

French: 1-800-268-6334

## WARRANTY

---

### U.S.A. EPA EMISSIONS LIMITED WARRANTY

This emissions limited warranty is in addition to the POLARIS standard limited warranty for your vehicle. POLARIS Industries Inc. warrants that at the time it is first purchased, this emissions-certified vehicle is designed, built and equipped so it conforms with applicable U.S. Environmental Protection Agency emission regulations. POLARIS warrants that the vehicle is free from defects in materials and workmanship that would cause it to fail to meet these regulations.

The warranty period for off road vehicles 100cc or greater emissions-certified vehicles starts on the date of purchase by original retail purchaser and continues for a period of 500 hours of engine operation, 5000 kilometers (3100 miles) of vehicle travel, or 30 calendar months from the date of purchase, whichever comes first. The warranty period for ATVs less than 100cc emissions-certified vehicles starts on the date of purchase by original retail purchaser and continues for a period of 250 hours of engine operation, 2500 kilometers (1550 miles) of vehicle travel, or 30 calendar months from the date of purchase, whichever comes first. This EPA emissions warranty period is extended for at least as long as the standard factory warranty that Polaris provides on the vehicle as a whole. The EPA emissions warranty period does not further extend if you purchase additional warranty coverage in the form of a service contract or other paid warranty extension, but emission-related parts may be covered subject to the terms of any such paid service contract or paid warranty extension.

This emissions limited warranty covers components whose failure increases the vehicle's regulated emissions, and it covers components of systems whose only purpose is to control emissions. Repairing or replacing other components not covered by this warranty is the responsibility of the vehicle owner. This emissions limited warranty does not cover components whose failure does not increase the vehicle's regulated emissions.

For exhaust emissions, emission-related components include any engine parts related to the following systems:

- Air-induction system
- Fuel system
- Ignition system
- Exhaust gas recirculation systems

The following parts are also considered emission-related components for exhaust emissions:

- Aftertreatment devices
- Crankcase ventilation valves
- Sensors
- Electronic control units

The following parts are considered emission-related components for evaporative emissions:

- Fuel Tank
- Fuel Cap
- Fuel Line
- Fuel Line Fittings
- Clamps\*
- Pressure Relief Valves\*
- Control Valves\*
- Control Solenoids\*
- Electronic Controls\*
- Vacuum Control Diaphragms\*
- Control Cables\*
- Control Linkages\*
- Purge Valves
- Vapor Hoses
- Liquid/Vapor Separator
- Carbon Canister
- Canister Mounting Brackets
- Carburetor Purge Port Connector

\*As related to the evaporative emission control system.

Emission-related components also include any other part whose only purpose is to reduce emissions or whose failure will increase emissions without significantly degrading engine/equipment performance. The exclusive remedy for breach of this limited warranty shall be, at the exclusive option of POLARIS, repair or replacement of any defective materials, components or products. THE REMEDIES SET FORTH IN THIS LIMITED WARRANTY ARE THE ONLY REMEDIES AVAILABLE TO ANY PERSON FOR BREACH OF THIS WARRANTY. POLARIS SHALL HAVE NO LIABILITY TO ANY PERSON FOR INCIDENTAL, CONSEQUENTIAL OR SPECIAL DAMAGES OF ANY DESCRIPTION, WHETHER ARISING OUT OF EXPRESS OR IMPLIED WARRANTY OR ANY OTHER CONTRACT, NEGLIGENCE OR OTHER TORT OR OTHERWISE. THIS EXCLUSION OF CONSEQUENTIAL, INCIDENTAL, AND SPECIAL DAMAGES IS INDEPENDENT FROM AND SHALL SURVIVE ANY FINDING THAT THE EXCLUSIVE REMEDY FAILED OF ITS ESSENTIAL PURPOSE.

ALL IMPLIED WARRANTIES (INCLUDING BUT NOT LIMITED TO ANY IMPLIED WARRANTIES OF MERCHANTABILITY AND FITNESS FOR A PARTICULAR PURPOSE) ARE LIMITED IN DURATION TO THE WARRANTY PERIOD DESCRIBED HEREIN. POLARIS DISCLAIMS ALL EXPRESS WARRANTIES NOT STATED IN THIS WARRANTY. Some states do not allow limitations on how long an implied warranty lasts, so the above limitation may not apply if it is inconsistent with the controlling state law.

This limited warranty excludes failures not caused by a defect in material or workmanship. This limited warranty does not cover damage due to accidents, abuse or improper handling, maintenance or use. This limited warranty also does not cover any engine that has been structurally altered, or when the vehicle has been used in racing competition. This limited warranty also does not cover physical damage, corrosion or defects caused by fire, explosions or other similar causes beyond the control of POLARIS.

## WARRANTY

---

Owners are responsible for performing the scheduled maintenance identified in the owner's manual. POLARIS may deny warranty claims for failures that have been caused by the owner's or operator's improper maintenance or use, by accidents for which POLARIS has no responsibility, or by acts of God.

Any qualified repair shop or person may maintain, replace, or repair the emission control devices or systems on your vehicle. An authorized POLARIS dealer, or other qualified person, can perform any service that may be necessary for your vehicle. POLARIS also recommends POLARIS parts, however equivalent parts may be used for such service. It is a potential violation of the Clean Air Act if a part supplied by an aftermarket parts manufacturer reduces the effectiveness of the vehicle's emission controls. Tampering with emission controls is prohibited by federal law.

### **CALIFORNIA RESIDENTS**

Certain POLARIS Off-Road Vehicles are available in 49-state and 50-state versions. Only the 50-state models are certified for sale in California. The 50-state models available for sale in California are identified by the letter "B" in the ninth position of the model number (e.g., R16RTE87B). The POLARIS 50-state models are designed and built with features such as a reduced cargo box capacity. Any modifications to these features may be a violation of the applicable California regulations and may void this limited emissions warranty offered by the manufacturer.

If you have any questions regarding your warranty rights and responsibilities, please contact POLARIS Customer Assistance:

United States & Canada: 1-800-POLARIS (1-800-765-2747)

French: 1-800-268-6334

## MAINTENANCE LOG

### MAINTENANCE LOG

Use the following chart to record periodic maintenance.

DATE	MILES (KM) OR HOURS	TECHNICIAN	SERVICE PERFORMED / COMMENTS



---

2X4 Mode .....	48
2X4 Mode (Utility Edition and UTE Models) .....	50
4X4 (AWD) Warning .....	28
4X4 Mode .....	48
4x4 Switch .....	38

## A

Active Descent Control (ADC) System .....	51
ADC 4X4 Mode .....	48
ADC AWD Mode (Utility Edition and UTE Models) .....	51
Age 16 Warning .....	25-26, 33
Age Restrictions .....	13
Air Filter .....	121
Air Filter / Air Box .....	138
All Wheel Drive System .....	48
All Wheel Drive System (Utility Edition and UTE models) .....	50
Automatic Transmission Gear Selector .....	45
Auxiliary Foot Brake .....	44, 115
Auxiliary Outlet .....	39
AWD Mode (Utility Edition and UTE models) .....	50
AWD Warning .....	35

## B

Battery .....	132
Installation .....	133
Battery Charging .....	135
Battery Maintenance .....	139
Battery Removal .....	132
Battery Storage .....	135
Boots .....	12
Box Warning (X2) .....	35
Brake Fluid Level .....	44
Brake Lever .....	41
Brake System Break-in .....	70
Brakes .....	115
Braking .....	84

## C

Camber and Caster .....	136
Cargo Box Dumping (X2 and UTE) .....	88
Cargo Warning .....	85
Clean the Exterior .....	138
Clothing .....	12
Clutch Cover Warning .....	27, 33
Cold Weather Operation .....	74
Cooling System .....	113
Crankcase Emission Control System .....	101
Crossing Hillsides .....	16

## D

Descending Hills Improperly .....	16
Diagnostic Display Code Definitions .....	64
Discretionary Warning .....	26-27, 31
Disengaging Active Descent Control .....	51
Drive Belt Wear/Burn .....	167
Driving in Reverse .....	82
Driving on a Sidehill (Sidehilling) ...	81
Driving on Slippery Surfaces .....	76
Driving Over Obstacles .....	78
Driving Through Water .....	77
Driving Uphill .....	79

## E

Electromagnetic Interference .....	101
Electronic Power Steering (EPS) ...	47
Emissions Limited Warranty .....	176
Engaging 4X4 .....	49
Engaging Active Descent Control .....	51
Engine and Drivetrain Break-in .....	70
Engine Backfires .....	168
Engine Doesn't Turn Over .....	168
Engine Oil .....	107
Engine Pings or Knocks .....	169
Engine Runs Irregularly, Stalls or Misfires .....	169

Engine Stop Switch .....	38
Engine Stopping .....	84
Engine Stops or Loses Power ....	170
Engine Turns Over, Fails to Start .....	168
European Vibration and Noise .....	9
Exhaust Emission Control System .....	101
Exported Products .....	175
Exposure to Exhaust .....	14
Extreme Use Battery .....	48
Eye Protection .....	12

## F

Failure to Inspect Before Operating .....	14
Fluid Levels .....	138
Fluid Part Numbers .....	165
Fog the Engine .....	139
Footwell Removal (1-Up Models) .....	116-117
Front Gearcase (Demand Drive) Fluid .....	112
Front Wheel Hub Tightening .....	117
Fuel Cap .....	46
Fuel Stabilizer .....	138
Fuel Transport Warning .....	30-31
Fuel Transport Warning (6x6 Models) .....	25
Fuse Replacement .....	121

## G

General Warning .....	22-23, 29-30
Gloves .....	12

## H

Hand Brake .....	115
Handlebars .....	136
Handling Gasoline .....	14
Hauling Cargo .....	86
Headlight Housing Replacement .....	124

Headlight Lamp Replacement ....	122
Headlight Switch .....	39
Helmet .....	12
High Beam Adjustment .....	123
Hot Exhaust Systems .....	21
How To Obtain Warranty Service .....	174

## I

Ignition Switch/Light Switch .....	37
Improper Cargo Loading .....	20
Improper Hill Climbing .....	16
Inspect and Lubricate .....	139
Instrument Cluster Back Light Color .....	60
Back Light Level .....	61
Clock .....	59
Diagnostic Code .....	63
Display Area 1 .....	54
Display Area 2 .....	55
Indicator Lamps .....	53
Options Menu .....	56
Overview .....	52
Service Hours .....	62
Unit Selection Distance .....	57
Unit Selection Temperature .....	58

## J

Jumps and Stunts .....	16
------------------------	----

## K

Know Your Riding Area/Tread Lightly .....	73
---	----

## L

Lights .....	122
Limited Warranty .....	171
Low Beam Adjustment .....	124
Lower Headlamp Replacement ...	124
Lubricants / Service Products .....	165



---

Lubrication Guide .....	107
-------------------------	-----

## M

Maintenance Chart .....	104
Maintenance Log .....	179
Master Cylinder/Brake Fluid .....	42
Mode/Reverse Override Switch .....	38
Modifications to Vehicle .....	21

## N

New Operator Driving Procedures .....	74
Noise Emission Control System .....	101

## O

Oil and Filter .....	138
Oil and Filter Change .....	109
Oil Filter Change .....	110
Oil Level .....	108
Oil Recommendations .....	108
Operating at Excessive Speeds .....	15
Operating Improperly in Reverse .....	18
Operating in Unfamiliar Terrain .....	18
Operating on Frozen Bodies of Water .....	20
Operating on Pavement .....	14
Operating on Public Roads .....	15
Operating on Slippery Terrain .....	18
Operating on Steep Hills .....	18
Operating Over Obstacles .....	19
Operating Through Water .....	19
Operation on Public Lands in the U.S.A. ....	101

## P

Parking Brake .....	43
Parking on an Incline .....	83
Parking the Vehicle .....	84
Part Numbers .....	165

Passenger Seat (X2) .....	47
Passenger Seat Backrest (Touring) .....	46
Passenger Warning .....	31
Passenger Warning (6x6 Models) .....	25
Passenger Warning/ Discretionary Warning (2-Up Models) .....	24
Periodic Maintenance .....	103
Physical Control of the Vehicle .....	15
Physical Skills .....	20
Polaris Products .....	165
Polishing the Vehicle .....	137
Poor Visibility .....	20
Power Steering Unit (Cleaning) .....	113
Pre-Ride Checklist .....	71
Protective Apparel .....	14
PVT Break-in (Clutches/Belt) .....	70
PVT Drying .....	131
PVT System .....	129

## R

Rack Alert (7181584) .....	35
Rack Alert, Front (X2) .....	35
Rack/Box Warning .....	26
Radiator Coolant .....	114
Rear Spring .....	136
Recovery Bottle Coolant .....	114
Registration, Warranty .....	171
Reverse Override/AWD Warning .....	26, 34

## S

Safe Operation Practices .....	72
Safe Riding Gear .....	11
Safety Labels and Locations .....	22
Safety Symbols .....	8
Safety Training .....	11
Safety Warnings .....	13
Safety, Winch Maintenance .....	100
Seat Conversion .....	47
Seat Removal .....	116
Severe Use Definition .....	103

Shock Loading the Winch .....	99
Side Panel Removal .....	116
Signal Words .....	8
Skidding or Sliding .....	19
Spark Arrester .....	128
Spark Plug Inspection .....	126
Spark Plug Recommendations ...	126
Spark Plugs .....	126
Specifications .....	141, 147, 152, 154, 157, 159, 161
Specifications (450 HD 2x4) .....	143
Specifications (450 Utility Edition) .....	145
Specifications (570 HD) .....	150
Stabilize the Fuel .....	138
Stalling While Climbing a Hill .....	17
Starting the Engine .....	73
Steering Assembly .....	113
Stopping the Engine .....	84
Storage .....	138
Storage Area .....	139
Switches .....	37

## T

Taillights/Brake Lights	
Replacement .....	125
Throttle Lever .....	40
Tire Pressure/Load Warning... 27, 32- 33	
Tire Pressure/Load Warning (6x6) .....	28
Tire Pressure/Load Warning (Touring) .....	28
Tire Tread Depth .....	117
Tires .....	117
Toe Alignment .....	120
Towing Loads .....	86
Towing Your Vehicle .....	89
Trademarks .....	2
Trail Etiquette .....	73
Trailer Your Vehicle .....	89
Transmission Oil .....	111
Transporting the ATV .....	140
TURF Mode .....	49
Turning Around on a Hill (K- Turn) .....	75

Turning Improperly .....	15
--------------------------	----

## U

Unauthorized Use of the Vehicle ...	21
-------------------------------------	----

## V

Vehicle Break-in Period .....	69
Vehicle Identification Numbers .....	10
Vehicle Immersion .....	127

## W

Warning Symbols .....	8
Washing the Vehicle .....	137
Wet Fouled Plug .....	126
Wheel Installation .....	118
Wheel Nut Torque Specifications .....	119
Wheel Removal .....	118
Winch Cable Care .....	98
Winch Maintenance and Service Safety .....	100
Winch Operation .....	93
Winch Safety Precautions .....	91
Winch Shock Loading .....	99



# **WARNING**

**IMPROPER VEHICLE USE CAN RESULT  
IN SEVERE INJURY OR DEATH.**



ALWAYS USE  
AN APPROVED  
HELMET AND  
PROTECTIVE  
GEAR FOR  
DRIVER AND  
PASSENGER



NEVER  
USE ON  
PUBLIC  
ROADS



NEVER  
CARRY  
PASSENGERS  
ON A  
1-UP ATV  
(TYPE I)



NEVER  
CARRY MORE  
THAN 1  
PASSENGER  
ON A 2-UP  
ATV (TYPE II)



NEVER  
USE WITH  
DRUGS OR  
ALCOHOL

## **NEVER OPERATE:**

- *without proper ATV training or instruction.*
- *at speeds too fast for your skills or the conditions.*
- *on public roads - a collision can occur with another vehicle.*
- *(Type I / 1-Up ATV only) with a passenger - passengers affect balance and steering and increase risk of losing control*
- *(Type II / 2-Up ATV only) with a passenger unless passenger seat is securely in place*

## **THE OPERATOR MUST ALWAYS:**

- *use proper riding techniques to avoid vehicle overturns on hills and rough terrain and in turns.*
- *avoid paved surfaces - pavement may seriously affect handling and control.*
- *(Type II / 2-Up ATV only) reduce speed and use extra caution at all times when carrying a passenger - dismount passenger when conditions require*
- *(Type II / 2-Up ATV only) make sure passenger reads and understands all safety labels*

**READ OWNER'S MANUAL.**

**FOLLOW ALL INSTRUCTIONS AND WARNINGS.**

For your nearest Polaris dealer,  
call 1-800-POLARIS (765-2747)  
or visit [www.polaris.com](http://www.polaris.com)



Polaris Industries Inc.  
2100 Highway 55  
Medina, MN 55340

Part No. 9929536 Rev 02  
Printed in USA

